

KENWOOD

AUDIO VIDEO SURROUND RECEIVER

VR-7080 KRF-X9070D

INSTRUCTION MANUAL

KENWOOD CORPORATION

This instruction manual is for some models. Model availability and features (functions) may differ depending on the country and sales area.

About the supplied remote control

Compared to standard remote controls, the remote control supplied with this receiver has several operation modes. These modes enable the remote control to control other audio/video components. In order to effectively use the remote control, it is important to read the operating instructions and obtain a proper understanding of the remote control and how to switch its operation modes (etc.). Using the remote control without completely understanding its design and how to switch the operation modes may result in incorrect operations.

Before applying the power

 **Caution : Read this page carefully to ensure safe operation.**

Units are designed for operation as follows.

U.S.A. and Canada	AC 120 V only
Australia	AC 240 V only
Europe and U.K	AC 230 V only
China and Russia	AC 220 V only
Other countries	AC 110-120 / 220-240 V switchable*

* AC voltage selection

The AC voltage selector switch on the rear panel is set to the voltage that prevails in the area to which the unit is shipped. Before connecting the power cord to your AC outlet, make sure that the setting position of this switch matches your line voltage. If not, it must be set to your voltage in accordance with the following direction.

AC voltage selector switch

Move switch lever to match your line voltage with a small screwdriver or other pointed tool.

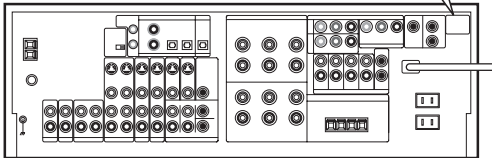
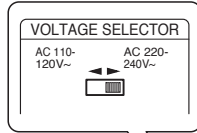

Note:

Our warranty does not cover damage caused by excessive line voltage due to improper setting of the AC voltage selector switch.

How to use this manual

This manual is divided into four sections, Preparations, Operations, Remote Control, and Additional Information.

Preparations

Shows you how to connect your audio and video components to the receiver and prepare the surround processor.

Since this receiver works with all your audio and video components, we will guide you in setting up your system to be as easy as possible.

Operations

Shows you how to operate the various functions available on the receiver.

Remote Control

Shows you how to operate other components using the remote control, as well as a detailed explanation of all remote control operations. Once you have registered your components with the proper setup codes, you'll be able to operate both this receiver and your other AV components (TV, VCR, DVD player, CD player, etc.) using the remote control supplied with this receiver.

Additional Information

Shows you additional information such as "In case of difficulty" (troubleshooting) and "Specifications".

Safety precautions

WARNING :

TO PREVENT FIRE OR ELECTRIC SHOCK, DO NOT EXPOSE THIS APPLIANCE TO RAIN OR MOISTURE.



CAUTION

RISK OF ELECTRIC SHOCK
DO NOT OPEN



CAUTION: TO REDUCE THE RISK OF ELECTRIC SHOCK, DO NOT REMOVE COVER (OR BACK). NO USER-SERVICEABLE PARTS INSIDE. REFER SERVICING TO QUALIFIED SERVICE PERSONNEL.





THE LIGHTNING FLASH WITH ARROWHEAD SYMBOL, WITHIN AN EQUILATERAL TRIANGLE, IS INTENDED TO ALERT THE USER TO THE PRESENCE OF UNINSULATED "DANGEROUS VOLTAGE" WITHIN THE PRODUCT'S ENCLOSURE THAT MAY BE OF SUFFICIENT MAGNITUDE TO CONSTITUTE A RISK OF ELECTRIC SHOCK TO PERSONS.



THE EXCLAMATION POINT WITHIN AN EQUILATERAL TRIANGLE IS INTENDED TO ALERT THE USER TO THE PRESENCE OF IMPORTANT OPERATING AND MAINTENANCE (SERVICING) INSTRUCTIONS IN THE LITERATURE ACCOMPANYING THE APPLIANCE.

Contents

Caution : Read the pages marked  carefully to ensure safe operation.

Preparations	 Before applying the power 2
	 Safety precautions 2
	How to use this manual 2
	Unpacking 4
	Preparing the remote control 4
	Special features 6
	Names and functions of parts 7
	Main unit 7
	Remote control unit 8
	Setting up the system 10
	Connecting the terminals 11
	Connecting audio components 12
	Connecting video components 13
	Digital connections 14
	Connecting video components (COMPONENT VIDEO) 15
	Connecting a DVD player (6-channel input) 16
	Connecting the speakers 17
PRE OUT connections 18	
Connecting to another room (ROOM B) 19	
Connecting the external IR Repeater 20	
Connecting to the AV AUX jacks 21	
Connecting the antennas 21	
Connecting the system control 22	
Preparing for surround sound 23	
Speaker settings 23	

Operations	Normal playback 26
	Preparing for playback 26
	Listening to a source component 26
	Adjusting the sound 27
	Recording 29
	Recording audio (analog sources) 29
	Recording video 29
	Recording audio (digital sources) 29
	Listening to radio broadcasts 30
	Tuning radio stations 30
	Presetting radio stations manually 30
Receiving preset stations 31	
Receiving preset stations in order (P.CALL) ... 31	
Ambience effects 32	
Surround modes 32	
Surround play 35	
DVD 6-channel playback 36	
Convenient functions 37	

Remote Control

Basic remote control operations for other components 40

Registering setup codes for other components 40
Searching for your codes 40
Checking the codes 41
Re-assigning device keys 41
Operating other components 41
Storing the remote control code of the other components 42
Setup code chart 43
CASSETTE deck, CD player & MD recorder operations 47
Other components' operations 48

Additional Information

In case of difficulty 50
 Specifications 52

Unpacking

Unpack the unit carefully and make sure that all accessories are present.

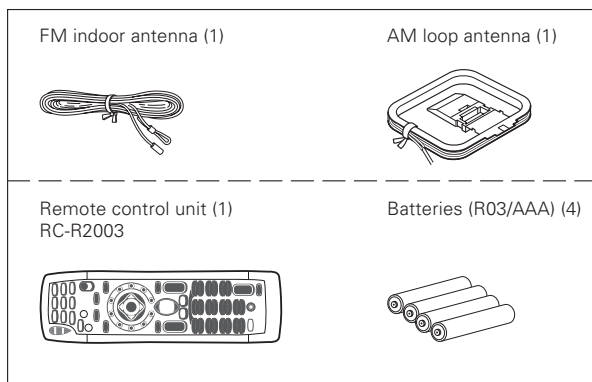

If any accessories are missing, or if the unit is damaged or fails to operate, notify your dealer immediately. If the unit was shipped to you directly, notify your shipper immediately. Kenwood recommends that you retain the original carton and packing materials in case you need to move or ship the unit in the future.

Keep this manual handy for future reference.

Memory back up function

Please note that the following items will be deleted from the unit's memory if the power cord is disconnected from the AC outlet for approximately 1 day.

- Power mode.
- Input selector settings.
- Picture output.
- Speaker ON/OFF.
- Volume level.
- BASS, TREBLE, INPUT level.
- TONE ON/OFF.
- LOUDNESS ON/OFF.
- Dimmer level.
- MD/TAPE settings.
- Listen mode setting.
- Speaker settings.
- SURR : MIX ON/OFF.
- SW RE-MIX ON/OFF.
- Distance setting.
- Bass peak level.
- Display mode.
- Input mode setting.
- Midnight mode setting.
- PRO LOGIC II mode setting.
- CS II mode setting.
- Broadcast band.
- Frequency setting.
- Preset stations.
- Tuning mode.
- THX mode.
- DSP mode.
- ACTIVE EQ mode.
- SPEAKER EQ mode.

Preparing the remote control

Loading the batteries

① Remove the cover.

② Insert the batteries.

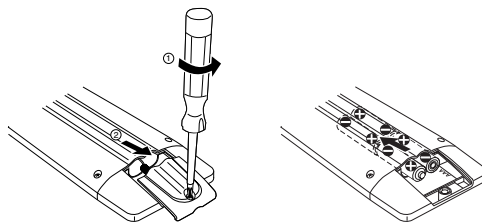

③ Close the cover.

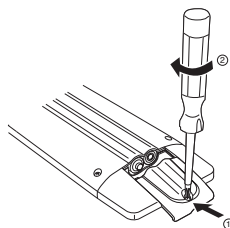

- Insert four AAA-size (R03) batteries as indicated by the polarity markings.

Remote control operation

When the **STANDBY** indicator is lit, the power turns ON when you press the **RCVR PWR (receiver power)** key on the remote control. When the power comes ON, press the key you want to operate.

Operating range (Approx.)

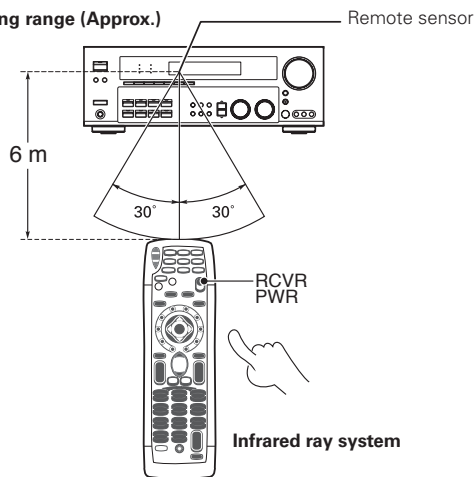

- When pressing more than one remote control key successively, press the keys securely by leaving an interval of 1 second or more between keys.

Notes

1. The supplied batteries may have shorter lives than ordinary batteries due to use during operation checks.
2. When the remote-controllable distance gets shorter than before, replace all batteries with new ones.
3. Placing the remote sensor in direct sunlight, or in direct light from a high frequency fluorescent lamp may cause malfunction. In such a case, change the location of the system installation to prevent malfunction.

Before applying the power

For the U.S.A.

FCC WARNING

This equipment may generate or use radio frequency energy. Changes or modifications to this equipment may cause harmful interference unless the modifications are expressly approved in the instruction manual. The user could lose the authority to operate this equipment if an unauthorized change or modification is made.

NOTE:

This equipment has been tested and found to comply with the limits for a Class B digital device, pursuant to Part 15 of the FCC Rules. These limits are designed to provide reasonable protection against harmful interference in a residential installation. This equipment may cause harmful interference to radio communications, if it is not installed and used in accordance with the instructions. However, there is no guarantee that interference will not occur in a particular installation. If this equipment does cause harmful interference to radio or television reception, which can be determined by turning the equipment off and on, the user is encouraged to try to correct the interference by one or more of the following measures:

- Reorient or relocate the receiving antenna.
- Increase the separation between the equipment and receiver.
- Connect the equipment into an outlet on a circuit different from that to which the receiver is connected.
- Consult the dealer or an experienced radio / TV technician for help.

For the U.S.A.

Note to CATV system installer

This reminder is provided to call the CATV system installer's attention to Article 820-40 of the NEC that provides guidelines for proper grounding and, in particular, specifies that the cable ground shall be connected to the grounding system of the building, as close to the point of cable entry as practical.



As an ENERGY STAR® Partner, Kenwood Corporation has determined that this product meets the ENERGY STAR® guidelines for energy efficiency. This product can save energy. Saving energy reduces air pollution

and lowers utility bills.

Maintenance of the unit

When the front panel or case becomes dirty, wipe with a soft, dry cloth. Do not use thinner, benzine, alcohol, etc. for these agents may cause discoloration.

In regard to contact cleaner

Do not use contact cleaners because it could cause a malfunction. Be specially careful not to use contact cleaners containing oil, for they may deform the plastic component.

Channel space switching

(Except for the U.S.A., Canada, U.K., and Australia)

The space between radio channels has been set to the one that prevails in the area to which the system is shipped. However, if the current channel space setting does not match the setting in the area where the system is to be used, for instance when you move from area 1 or area 2 shown in the following table or vice versa, proper reception of AM/FM broadcasts cannot be expected. In this case, change the channel space setting in accordance with your area by referring to the following table.

	Area	CHANNEL Space Frequency
1	U.S.A., Canada and South American countries	FM: 100 kHz AM: 10 kHz
2	Other countries	FM: 50 kHz AM: 9 kHz

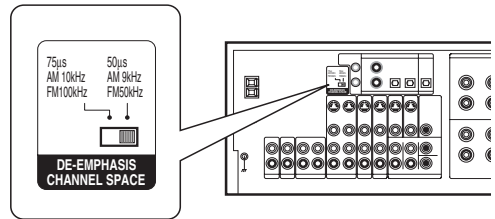

Turn the power OFF by pressing the POWER key before moving the switch lever. Move switch lever to match your area with a small screwdriver or other pointed tool, then turn the power on again.

Special features

True home theater sound

This receiver incorporates a wide variety of surround modes to bring you maximum enjoyment from your video software. Select a surround mode according to your equipment or the software you are going to play and enjoy! → [32]

THX

THX mode activates proprietary THX features that help recreate the cinematic experience in a home environment. → [36]

THX Surround EX

During THX Surround EX mode, film soundtracks that have been encoded with Dolby Digital Surround EX technology are able to reproduce an extra channel which has been added during the mixing of the program. This channel is called Surround Back.

THX Surround EX mode activates proprietary THX features that help recreate the cinematic experience in a home environment. → [36]

Dolby Digital and Dolby Digital EX

The DOLBY DIGITAL mode lets you enjoy full digital surround from software processed in the Dolby Digital format. Dolby Digital provides up to 5.1 channels of independent digital audio for better sound quality and more powerful presence than conventional Dolby Surround.

As for Dolby Digital EX, it creates six full-bandwidth output channels from the 5.1 channel sources. This is done using a matrix decoder that derives three surround channels from the two in the original recording. For best results, Dolby Digital EX should be used with movie soundtracks recorded with Dolby Digital Surround EX.

Dolby PRO LOGIC II

DOLBY PRO LOGIC II, whilst totally compatible with its predecessor PRO LOGIC, provides greater advantages in surround sound. It allows the user to enjoy the conventional stereo or Dolby Surround with a convincing "5.1 like" presentation. PRO LOGIC II offers special features for controlling the overall spatial, dimensionality and frontal sound field imaging. PRO LOGIC II produces an impressive surround sound from video software marked  **DOLBY SURROUND** and three-dimensional space from music CD. When listening to music, you will be able to enjoy the experience of sheer STEREO surround sound.

DTS and DTS-ES

DTS (Digital Theater System) is a 5.1 channel digital audio format that provides five full spectrum channels and one low-frequency (subwoofer) channel for unprecedented clarity, optimum channel separation and a (wide) dynamic range.

DTS-ES (Extended Surround) presents 6.1 channels surround system with additional Surround Back channel which evolved from the conventional 5.1 channels surround system. DTS-ES format that was recorded in DVD, CD or LD comprises of two modes. DTS-ES Discrete 6.1 produce the discrete surround back which is completely independent and DTS-ES Matrix 6.1 produces the surround back which synthesized within the left and right surround channels using matrix technology. DTS-ES has perfect compatibility with the conventional 5.1 channels surround system. 6.1 channels surround with an additional surround back presents a more natural presence and surround effects by increasing the impression of the sound image from back.

Important:

When a DTS disc is played on a CD, LD or DVD player, noise may be output from the analog output. It is recommended that you connect the digital output of the player to the digital input of this unit.

Neo:6

Neo:6 is a new technology which was developed by DTS. It can produce high grade 6 channels surround with an astonishing fidelity from 2 channels content. Neo:6 has 2 mode, "CINEMA" mode is for movie playback and "MUSIC" mode is for music playback.

SRS Circle Surround II

SRS Circle Surround II™ improves on its predecessor CS-5.1™ resulting in the CS-6.1™ system, enabling you to listen to realistic, multi-channel, surround sound playback from a stereo source or conventional surround-encoded video source. You already enjoy listening to Dolby Digital /DTS multi-channel sound with your multi-speakers. Now you can listen to audio CDs, MDs, Broadcast and Home Theater using your multi-speakers. You will discover a new type of sound through SRS Circle Surround II.

DSP surround modes

The DSP (Digital Signal Processor) used for this receiver incorporates a variety of high quality adjustable sound fields, like "ARENA", "JAZZ CLUB", "THEATER", "STADIUM" and "DISCO". It is compatible with almost any kind of program source.

DVD 6-channel input

If you own a DVD player equipped with 6-channel output, this receiver allows you to obtain the full surround sound impact of DVD source material featuring multi-channel encoding. Since the source signals are digital and each channel is input independently, the resulting ambience is far superior to what can be achieved with conventional surround sound systems.

ACTIVE EQ

ACTIVE EQ mode will produce a more dynamic sound quality in any condition. You can enjoy a more impressive sound effect when ACTIVE EQ is turned on during Dolby Digital and DTS playback.

SPEAKER EQ

SPEAKER EQ function is to adjust the receiver's audio output characteristics with the speakers' characteristics which differs depending on the size of the speakers. Especially for the music sound source playback, the reproduced sound becomes more natural when adjusting the output characteristics. When activating the SPEAKER EQ function, you will be able to enjoy a more natural and dynamic sound experience even with small size speakers.

Universal IR (InfraRed) remote control

In addition to the basic receiver, the remote control supplied with this receiver can also operate almost all of your remote controllable audio and video components. Just follow the simple setup procedure to register the components you have connected.

Names and functions of parts

Main unit

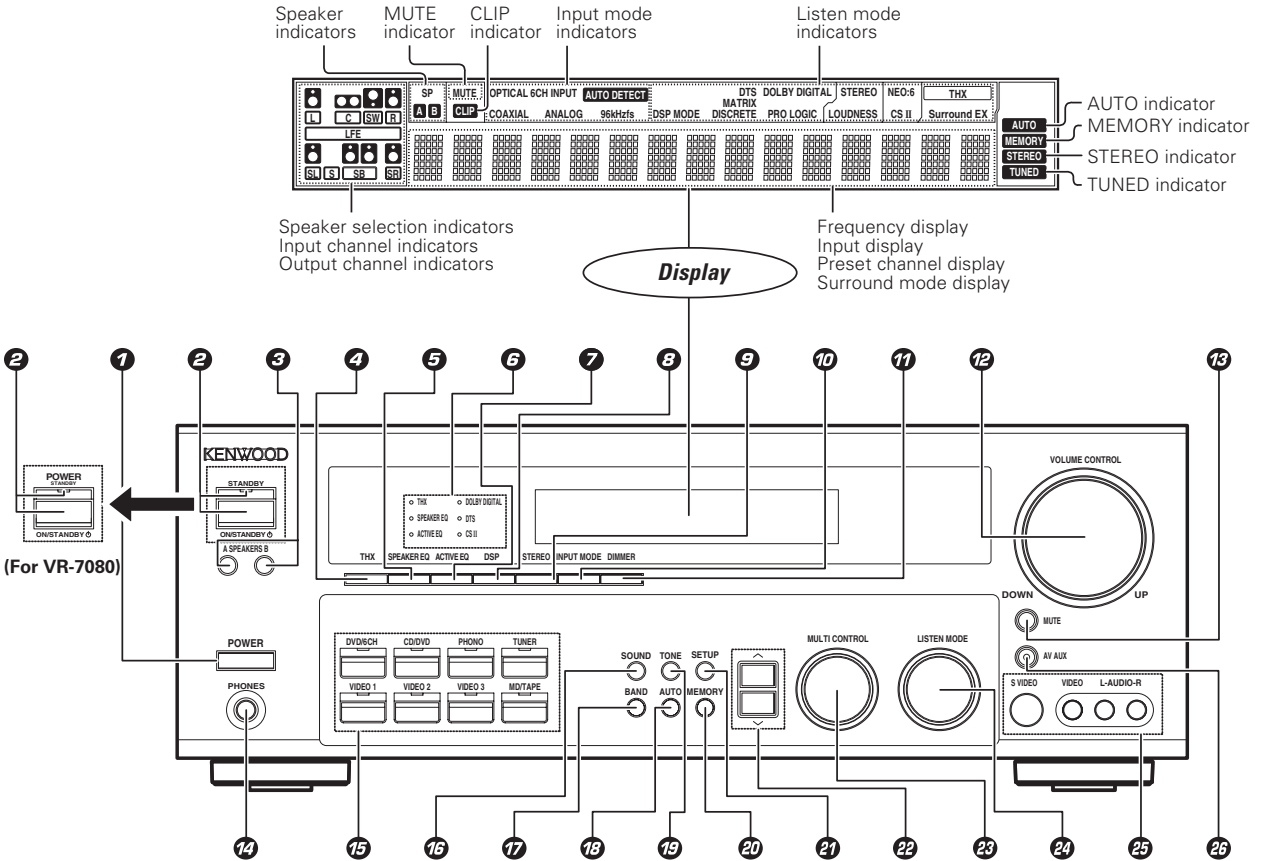

- 1 POWER ON/OFF key** (For KRF-X9070D) → [23]
Use to turn the main power ON/OFF.
- 2 ON/STANDBY key** (For KRF-X9070D) → [23]
Use to turn the power ON/STANDBY when the POWER is turned ON.
- 2 POWER ON/STANDBY key** (For VR-7080) → [23]
Use to turn the power ON/STANDBY.
- 3 SPEAKERS keys** → [26]
Use to turn the A/B speakers on or off.
- 4 THX key** → [35]
Use to switch the status of THX.
- 5 SPEAKER EQ key** → [27]
Use to select SPEAKER EQ's setting.
- 6 Surround LED (light-emitting diode) indicators** → [36]
Lights when THX mode has been chosen. THX mode may or may not be activated depending upon the applicable playback mode.
- 6 THX indicator** → [36]
Lights when THX mode has been chosen. THX mode may or may not be activated depending upon the applicable playback mode.
- 6 SPEAKER EQ indicator** → [28]
Lights when the receiver is in the SPEAKER EQ mode.
- 7 ACTIVE EQ key** → [27]
Use to select ACTIVE EQ's setting.
- 8 DOLBY DIGITAL indicator** → [35]
Lights when the receiver is in the Dolby Digital mode.
- 8 DTS indicator** → [35]
Lights when the receiver is in the DTS mode.
- 8 CS II indicator** → [35]
Lights when the receiver is in the CIRCLE SURROUND II mode.
- 9 DSP key** → [35]
Use to select any of the DSP mode.
- 9 STEREO key** → [37]
Use to switch the listen mode to STEREO.
- 10 INPUT MODE key** → [40]
Use to switch between the full auto, digital and analog inputs.
- 11 DIMMER key** → [29]
Use to select the REC MODE.
Use to adjust the brightness of the display.
- 12 VOLUME CONTROL knob** → [26]
Use to temporarily mute the sound.
- 13 MUTE key** → [27]
Use to temporarily mute the sound.
- 14 PHONES jack** → [28]
Use for headphone listening.
- 15 Input Selector keys** (DVD/6CH, CD/DVD, PHONO, TUNER, VIDEO 1, VIDEO 2, VIDEO 3, MD/TAPE) → [26]
Use to select input sources.
- 16 SOUND key** → [37]
Use to adjust the sound quality and the ambience effects.
- 17 BAND key** → [30]
Use to select the broadcast band.
- 18 AUTO key** → [30]
Use to select the auto or manual tuning mode.
- 19 TONE key** → [27]
Use to switch the status of TONE control.
- 20 MEMORY key** → [30]
Use to store radio stations in the preset memory.
- 21 SETUP key** → [23]
Use to select the speakers' settings etc.
- 22 A/V keys** → [23]
Use for selection adjustments during sound, set up and preset channel functions.
- 23 MULTI CONTROL knob** → [23]
Use to control a variety of settings.
- 23 LISTEN MODE knob** → [37]
Use to select the listening mode.
- 24 AV AUX (S VIDEO, VIDEO, L-AUDIO-R) jacks** → [21]
Use to switch the input to AV AUX.
- 25 AV AUX key** → [21]
Use to switch the input to AV AUX.

Standby mode

While the standby indicator is lit, a small amount of power is supplied to the system to back up the memory. This is called standby mode. Under the condition, the system can be turned ON by remote control unit.

for KRF-X9070D

CAUTION

The power in this equipment will not be completely cut off from the AC wall outlet when the main switch is turned OFF.

Remote control unit

- This remote control unit can be used not only for Kenwood products but also for other non-Kenwood products by setting the appropriate manufacturer's setup codes. → 43
- When you pick up the remote control unit or press any key, all keys will be illuminated and then the remote control unit will be activated with last active mode screen.

To switch ON or OFF the full illumination mode :

- 1 Press and hold the **LEARN** key for 3 seconds until the IR indicator blinks twice, then release the **LEARN** key.
 - 2 Press the Numeric keys to enter "9 - 7 - 8".
- If you don't use the remote control unit, put it under no tilt condition.
 - This remote control unit has "MAIN" screen mode and "SUB" screen mode. (see page 9, 9)

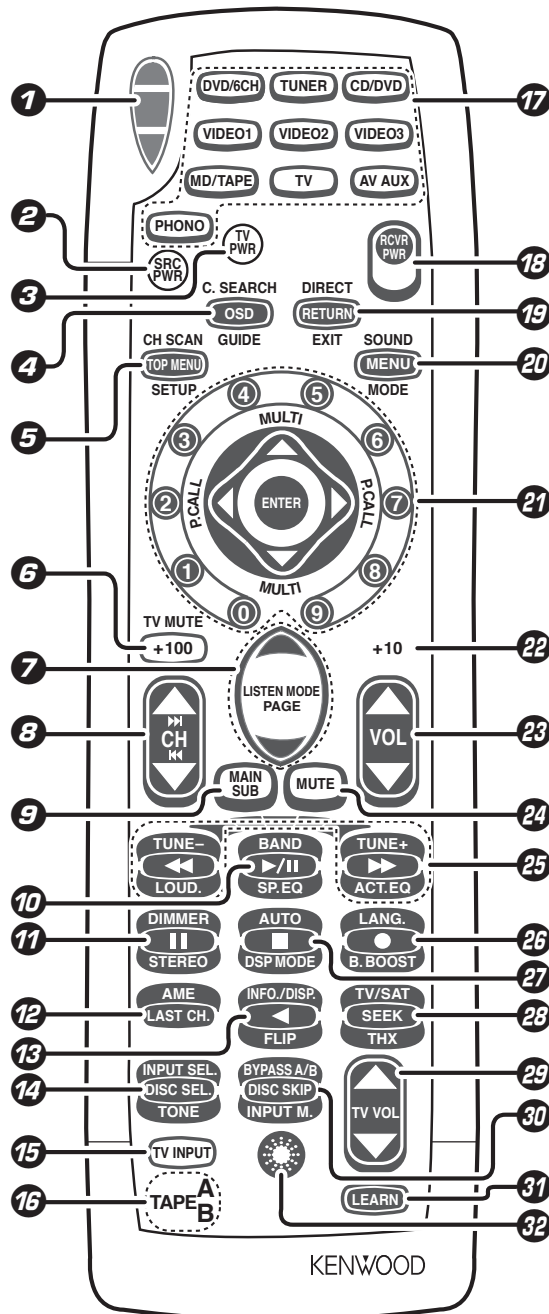

If the name of a function is different on the receiver and on the remote control, the name of the remote control key in this manual is indicated in parentheses.

- 1 IR (infrared) indicator**
The segments turn on and off to show signal transmission. - [40]
- 2 SRC PWR (source power) key**
Use to turn the other components on or off.
- 3 TV PWR (power) key**
Use to turn the TV on or off.
- 4 OSD (on screen display) key**
Use to operate the DVD component.
GUIDE key
Use to operate other components.
C. SEARCH (category search) key
Use to operate other components.
- 5 TOP MENU key**
Use to operate the DVD component.
SETUP key - [23]
Use to select the speakers' settings etc.
CH SCAN (channel scan) key
Use to operate other components.
- 6 +100 key**
Use to select the disc number with the multi-CD player.
TV MUTE key
Use to temporarily mute the TV sound.
- 7 LISTEN MODE ▲/▼ keys** - [37]
Use to select the listening mode.
PAGE ▲/▼ keys
Use to operate the DVD component.
- 8 CH Δ/▽ keys**
Use to select the channels.
▶▶/◀◀ keys
When in CD, MD and DVD player operations, these keys function as skip keys.
- 9 MAIN/SUB key**
Use to change between the main screen and the sub screen.
"MAIN" illumination: Lights when sub screen mode is activated
"SUB" illumination : Lights when main screen mode is activated
- 10 ▶/|| key**
If CD is selected as the input source, this key functions as the play/pause key.
If MD or TAPE key is selected as input source, this key functions as the play key.
SP. EQ (speaker equalizer) key - [27]
Use to select SPEAKER EQ's setting.
BAND key - [30]
Use to select the broadcast band.
- 11 II key**
Use to operate other components.
STEREO key - [37]
Use to switch the listen mode to STEREO.
DIMMER key - [37]
Use to adjust the brightness of the display.
- 12 LAST CH. (last channel) key**
Use to operate other components.
AME key
Use to operate other components.
- 13 ◀ key**
If Tape is selected, this key functions as reverse play key.
INFO./DISP. (information/display) key
Use to operate other components.
FLIP key
Use to operate the DVD component.
- 14 DISC SEL. (disc selection) key**
Use to operate other components.
TONE key - [27]
Use to switch the status of TONE control.
INPUT SEL. (input selection) key
Use to operate other components.
- 15 TV Input key**
Use when in TV operation.
- 16 TAPE A B display**
Use to display Tape A or Tape B system's setup.
- 17 Source keys (DVD/6CH, TUNER, CD/DVD, VIDEO1, VIDEO2, VIDEO3, MD/TAPE, TV, AV AUX, PHONO)** - [40]
When press and hold for more than 3 seconds, they are used to select the registered components.
Input Selector keys (DVD/6CH, TUNER, CD/DVD, VIDEO1, VIDEO2, VIDEO3, MD/TAPE, TV, AV AUX, PHONO) - [26]
When press and release in less than 3 seconds, they are used to select the input sources.
- 18 RCVR PWR (receiver power) key** - [23]
Use to turn the receiver on or off.
- 19 RETURN key**
Use to operate other components.
EXIT key
Use to operate other components.
DIRECT key
Use to operate other components.
- 20 MENU key**
Use to operate other components.
MODE key
Use to operate other components.
SOUND key - [37]
Use to adjust the sound quality and the ambience effects.
- 21 Numeric keys** - [40]
Provide functions identical to those of the original remote control supplied with the component you are controlling.
MULTI (multi control) Δ/▽/◀/▶ keys - [23]
Use to control a variety of settings.
Use to operate other components.
P.CALL ◀/▶ keys - [31]
Use to receive preset stations in order.
ENTER key
Use to operate other components.
- 22 +10 key**
Use as numeric key function.
- 23 VOL Δ/▽ keys** - [26]
Use to adjust the receiver's volume.
- 24 MUTE key** - [27]
Use to temporarily mute the sound.
- 25 ◀◀/▶▶ keys**
If CD, MD or Tape is selected as the input source, this key functions as search keys.
LOUD. (loudness) key - [27]
Use to switch the status of LOUDNESS.
ACT. EQ (active equalizer) key - [27]
Use to select ACTIVE EQ's setting.
TUNE - /+ keys
Use to operate the tuner mode.
- 26 ● key**
If VCR is selected, this key functions as record key.
B. BOOST (bass boost) key - [27]
Use to select the maximum adjustment setting for the low frequency range.
LANG. (language) key
Use to operate other components.
- 27 ■ key**
If CD, MD, or TAPE is selected as the input source, this key functions as the stop key.
DSP MODE key - [35]
Use to select any of the DSP mode.
AUTO key - [30]
Use to select the auto or manual tuning mode.
- 28 SEEK key**
Use to operate other components.
THX key - [35]
Use to switch the status of THX.
TV/SAT key
Use to operate other components.
- 29 TV VOL Δ/▽ keys**
Use to adjust the TV's volume.
- 30 DISC SKIP key**
If CD is selected as the input source, this key functions as the multi-CD player disc skip key.
INPUT M. (input mode) key
Use to switch between the full auto, digital and analog inputs.
BYPASS A/B key
If TAPE is selected as the input source, this is A and B deck of a double cassette deck.
Use to operate other components.
- 31 LEARN key** - [40]
Use to memorize the operation of the other remote controls.
- 32 ☀ (brightness) key**
Use to change the brightness of the remote control screen to toggle between current screen and brightness screen.
CH Δ/▽ keys will be used to adjust the brightness between 5 settings.

Setting up the system

Make connections as shown in the following pages. When connecting the related system components, be sure to refer to the instruction manuals supplied with the components you are connecting. Do not connect the power cord to a wall outlet until all connections are completed.

Notes

1. Be sure to insert all connection cords securely. If their connections are imperfect, sound may not be produced or there will be noise interference.
2. Be sure to remove the power cord from the AC outlet before plugging or unplugging any connection cords. Plugging/unplugging connection cords without disconnecting the power cord can cause malfunctions and may damage the unit.
3. Do not connect power cords from components whose power consumption is larger than what is indicated on the AC outlet at the rear of this unit.

Analog connections

Audio connections are made using RCA pin cords. These cables transfer stereo audio signal in an "analog" form. This means the audio signal corresponds to the actual audio of two channels. These cables usually have 2 plugs on each end, one red for the right channel and one white for the left channel. These cables are usually packed together with the source unit, or are available at your local electronics retailer.

Microcomputer malfunction

If operation is not possible or an erroneous display appears, even though all connections have been made properly, reset the microcomputer referring to "In case of difficulty". → 50

CAUTION

Be sure to adhere to the following, or proper ventilation will be blocked causing damage or fire hazard.

- Do not place any objects impairing heat radiation onto the top of the unit.
- Leave some space around the unit (from the largest outside dimension including projection) equal to or greater than, shown below.

Top panel : 50 cm Side panel : 10 cm Back panel : 10 cm

Input mode settings

CD/DVD, VIDEO 2, VIDEO 3 and DVD/6CH inputs each include jacks for digital audio input and analog audio input.

The initial factory settings for audio signal playback for CD/DVD, DVD/6CH, VIDEO 2 and VIDEO 3 are full auto.

After completing connections and turning on the receiver, follow the steps below.

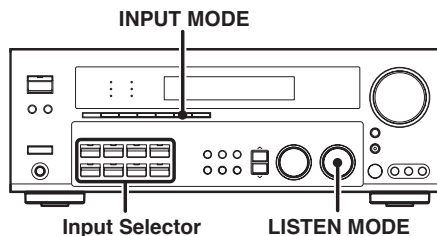

- 1 Use the Input Selector keys to select CD/DVD, VIDEO 2, VIDEO 3 or DVD/6CH.

- 2 Press the INPUT MODE key.

Each press switches the setting as follows:

In DTS play mode

- 1 FULL AUTO (digital input, analog input)
- 2 DIGITAL MANUAL (digital input)

In CD/DVD, VIDEO 2, VIDEO 3 or DVD/6CH play mode

- 1 FULL AUTO (digital input, analog input)
- 2 DIGITAL MANUAL (digital input)
- 3 6CH INPUT (DVD/6CH input)
- 4 ANALOG (analog input)

Digital input:

Select this setting to play digital signals from a DVD, CD, or LD player.

Analog input:

Select this setting to play analog signals from a cassette deck, VCR, or record player.

Auto detect:

In "FULL AUTO" mode (AUTO DETECT indicator light up), the receiver detects the digital or analog input signals automatically. Priority is given to digital signal during input mode selection. The receiver will select the input mode and listening mode automatically during playback to match the type of input signal (Dolby Digital, PCM, DTS) and the speaker setting. The OPTICAL and COAXIAL indicator on the display will light up when digital signal is detected. If the input signal is analog, the ANALOG indicator will light up.

To keep the receiver set to the currently selected listening mode, use the INPUT MODE key to select "DIGITAL MANUAL" (manual sound). However, even when this setting is selected, there may be cases in which the listening mode is selected automatically to match a Dolby Digital source signal depending on the combination of listening mode and source signal.

At DIGITAL MANUAL, if the audio reproduction stops in the middle due to change in the input signals, etc. press the LISTEN MODE knob.

If the INPUT MODE key is pressed quickly, sound may not be produced. Press the INPUT MODE key again.

Connecting the terminals

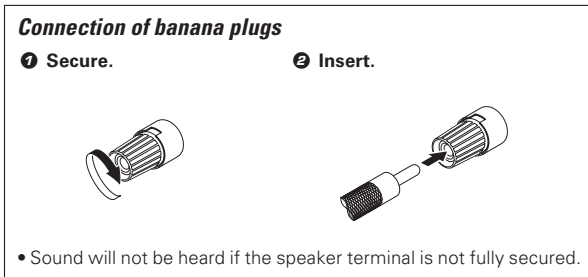
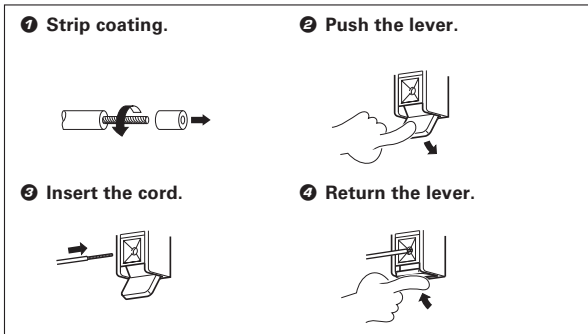
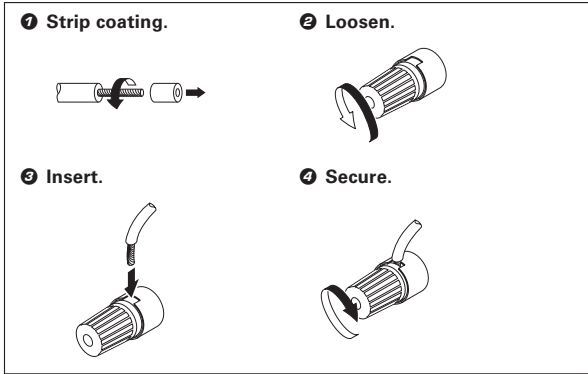

- Never short circuit the + and – speaker cords.
- If the left and right speakers are connected inversely or the speaker cords are connected with reversed polarity, the sound will be unnatural with ambiguous acoustic imaging. Be sure to connect the speakers correctly.

Speaker impedance

After confirming the speaker impedance indications printed on the rear panel of the receiver, connect speakers with matching impedance ratings. Using speakers with a rated impedance other than that indicated on the rear panel of the receiver could result in malfunctions or damage to the speakers or receiver.

Speaker placement

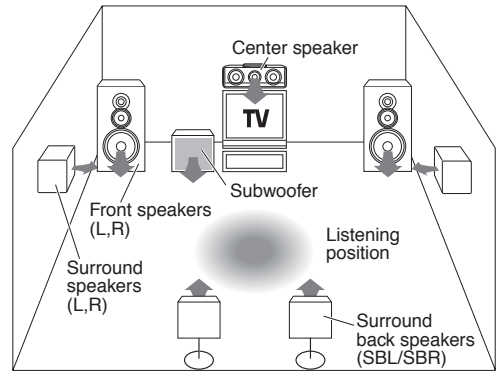

Front (left and right) speakers

Place at the front left and right of the listening position. Front speakers are required for all surround modes.

Center speaker

Place front and center. This speaker stabilizes the sound image and helps recreate sound motion. Required for surround playback.

Surround (left and right) speakers

Place at the direct left and right, or slightly behind, the listening position at even heights, approximately 1 meter above the ears of the listeners. These speakers recreate sound motion and atmosphere. Required for surround playback.

Subwoofer

Reproduces powerful deep bass sounds.

Surround back (left and right) speakers

Place the speaker directly at the rear of the listening position. The optimum position depends mainly on the room condition.

- Although the ideal surround system consists of all the speakers listed above, if you don't have a center speaker or a subwoofer, you can divide those signals between the available speakers in the speaker settings steps to obtain the best possible surround reproduction from the speakers you have available.

Connecting audio components

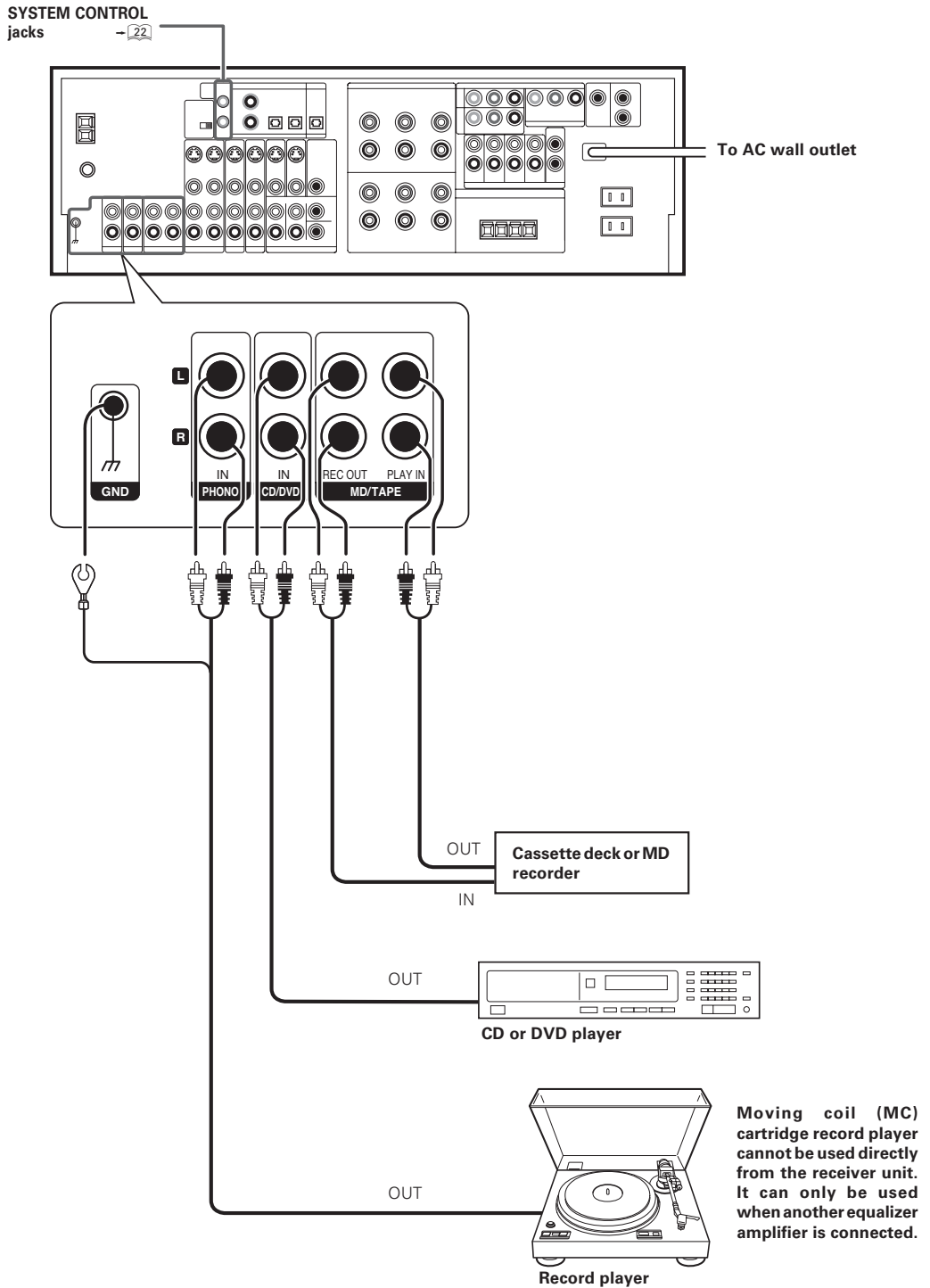

Connecting video components

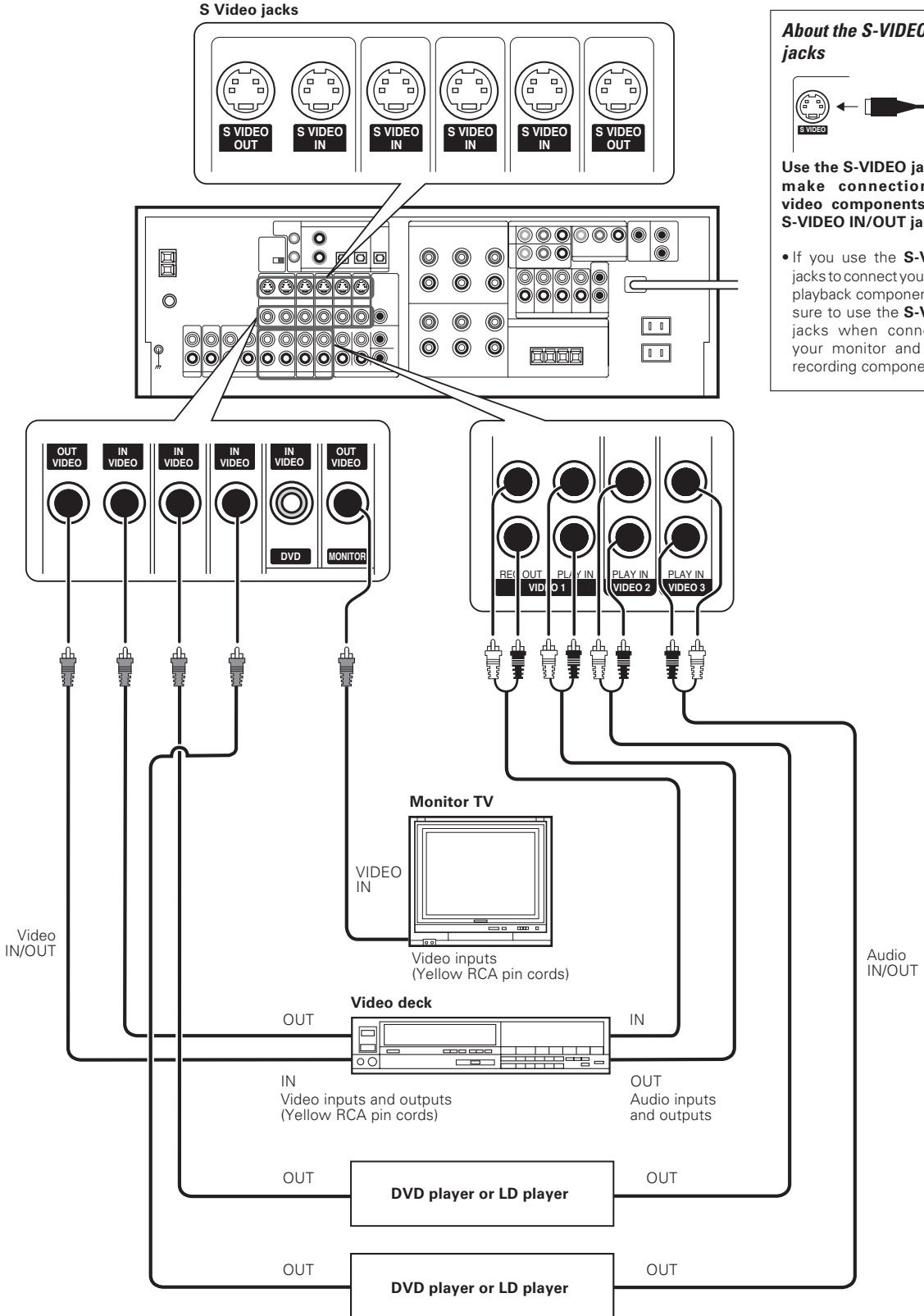

About the S-VIDEO jacks



Use the S-VIDEO jacks to make connections to video components with S-VIDEO IN/OUT jacks.

- If you use the S-VIDEO jacks to connect your video playback components, be sure to use the S-VIDEO jacks when connecting your monitor and video recording components.

A video component with digital audio outputs should be connected to the VIDEO 2 or VIDEO 3 jacks.

Digital connections

The digital in jacks can accept DTS, Dolby Digital, or PCM signals. Connect components capable of outputting DTS, Dolby Digital, or standard PCM (CD) format digital signals.

If you have connected any digital components to the receiver, be sure to read the "Input mode settings" section carefully.

- 19

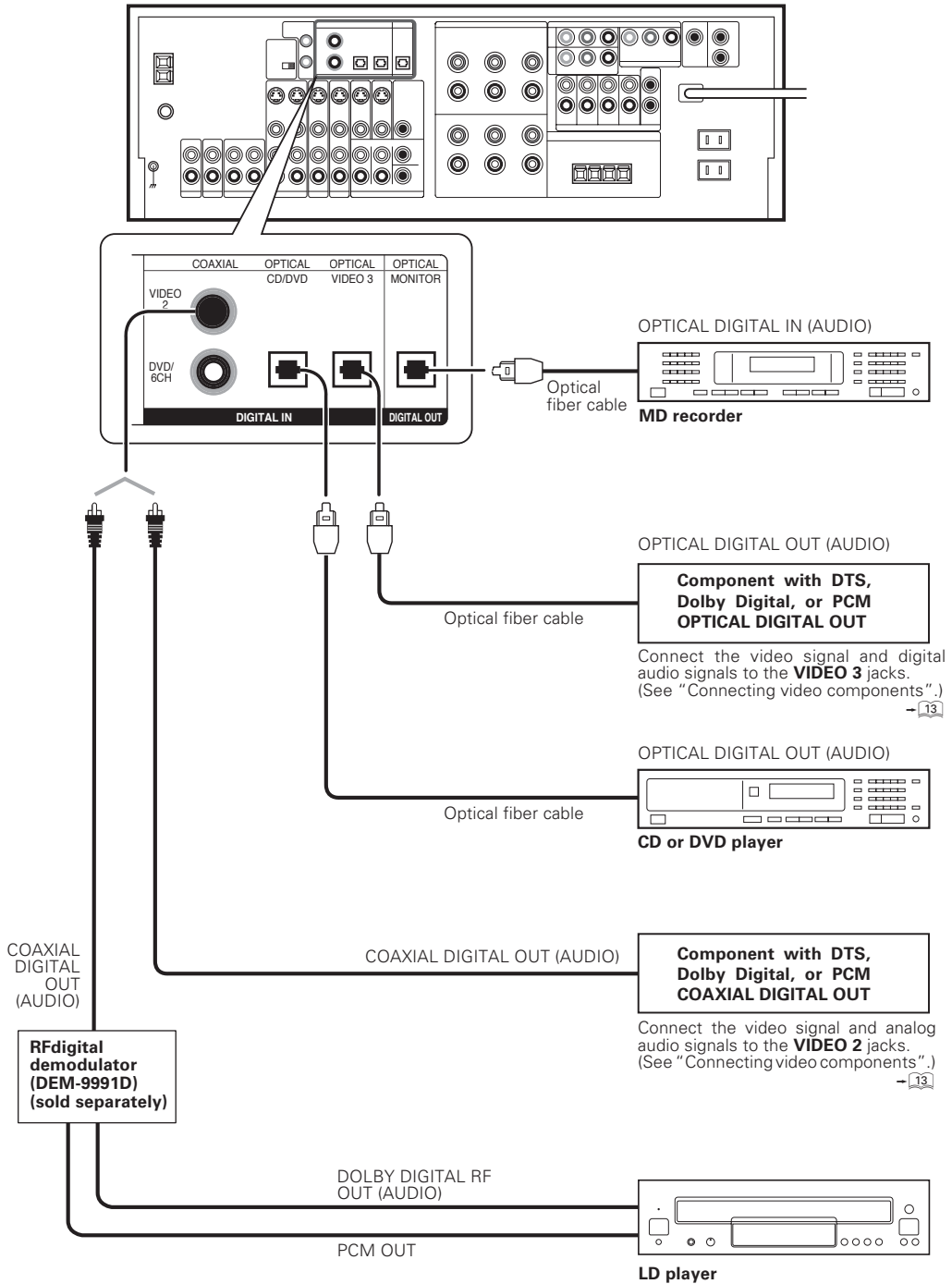

To connect an LD player with a DIGITAL RF OUT, connect the LD player to the KENWOOD RF digital demodulator (DEM-9991D). Next, connect the DIGITAL OUT jacks of the demodulator to the DIGITAL IN jacks of the receiver. Connect the video signal and analog audio signals to the VIDEO 2 or VIDEO 3 jacks. (See "Connecting video components".) The RF digital demodulator (DEM-9991D) may not be on the market in concern areas countries.

Connecting video components (COMPONENT VIDEO)

If you have connected the receiver to a video component with COMPONENT jacks, you can get a better picture quality than by connecting to the S-VIDEO jacks.

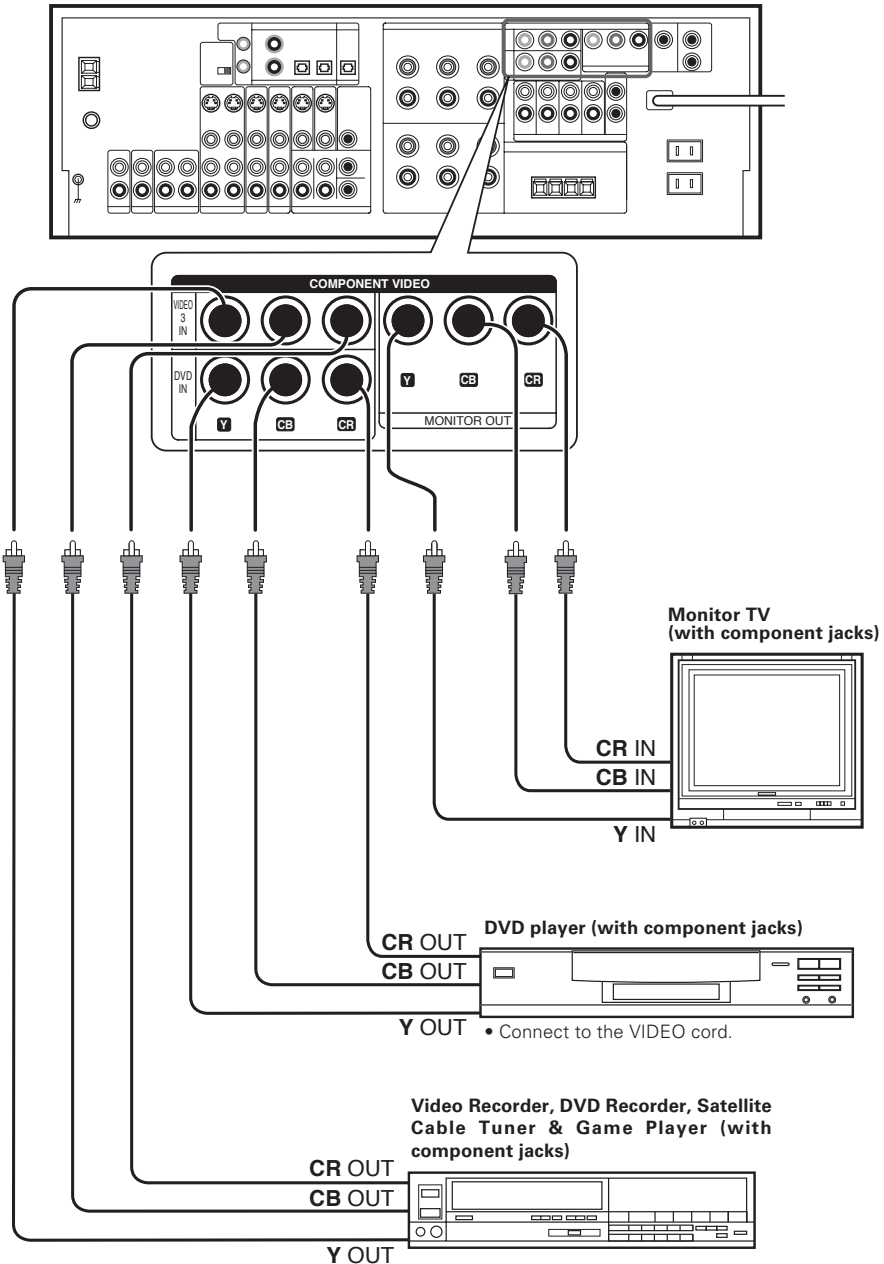

When connecting the TV to the COMPONENT jacks, be sure to connect all the other components to the COMPONENT jacks.

Connecting a DVD player (6-channel input)

If you have connected a DVD player to the receiver with digital connection, be sure to read the "Input mode settings" section carefully.

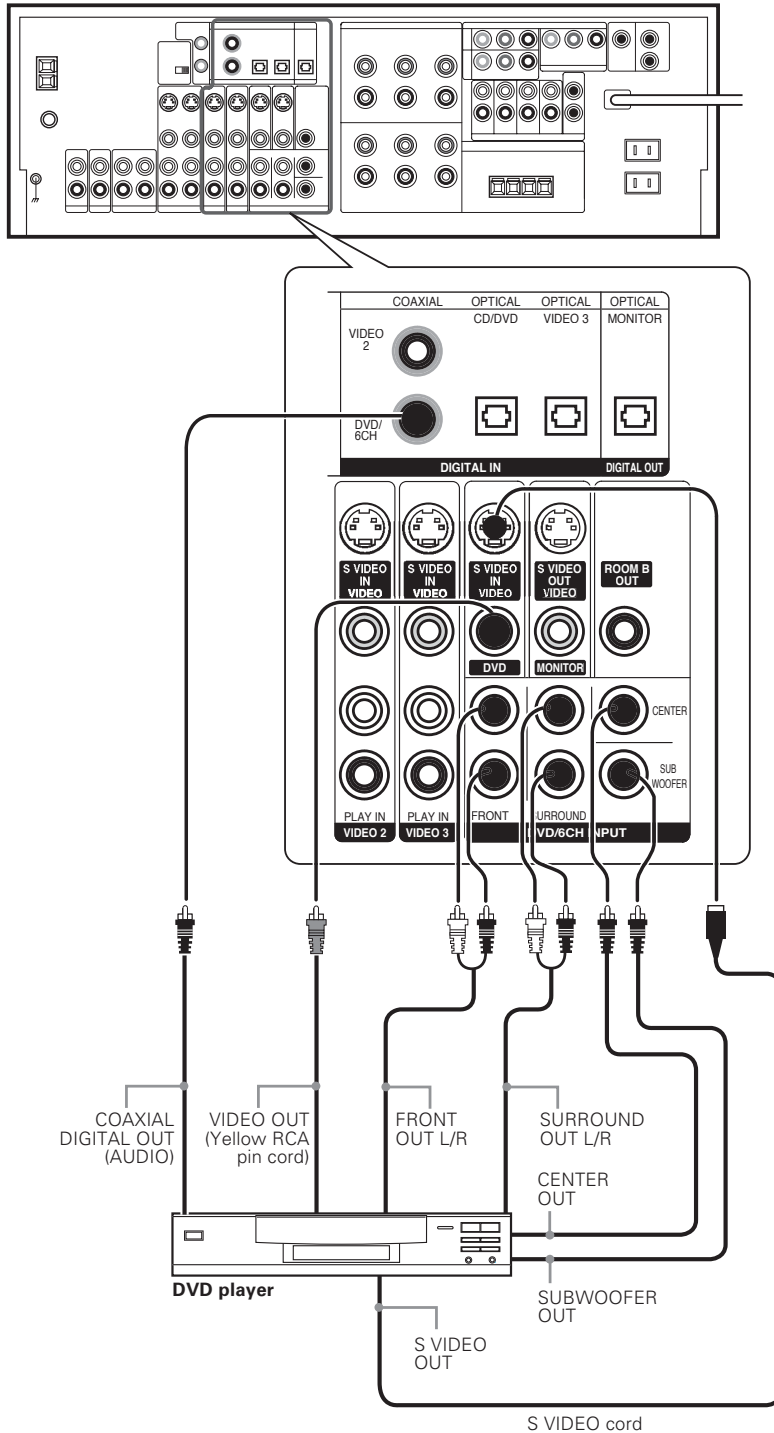

Connecting the speakers

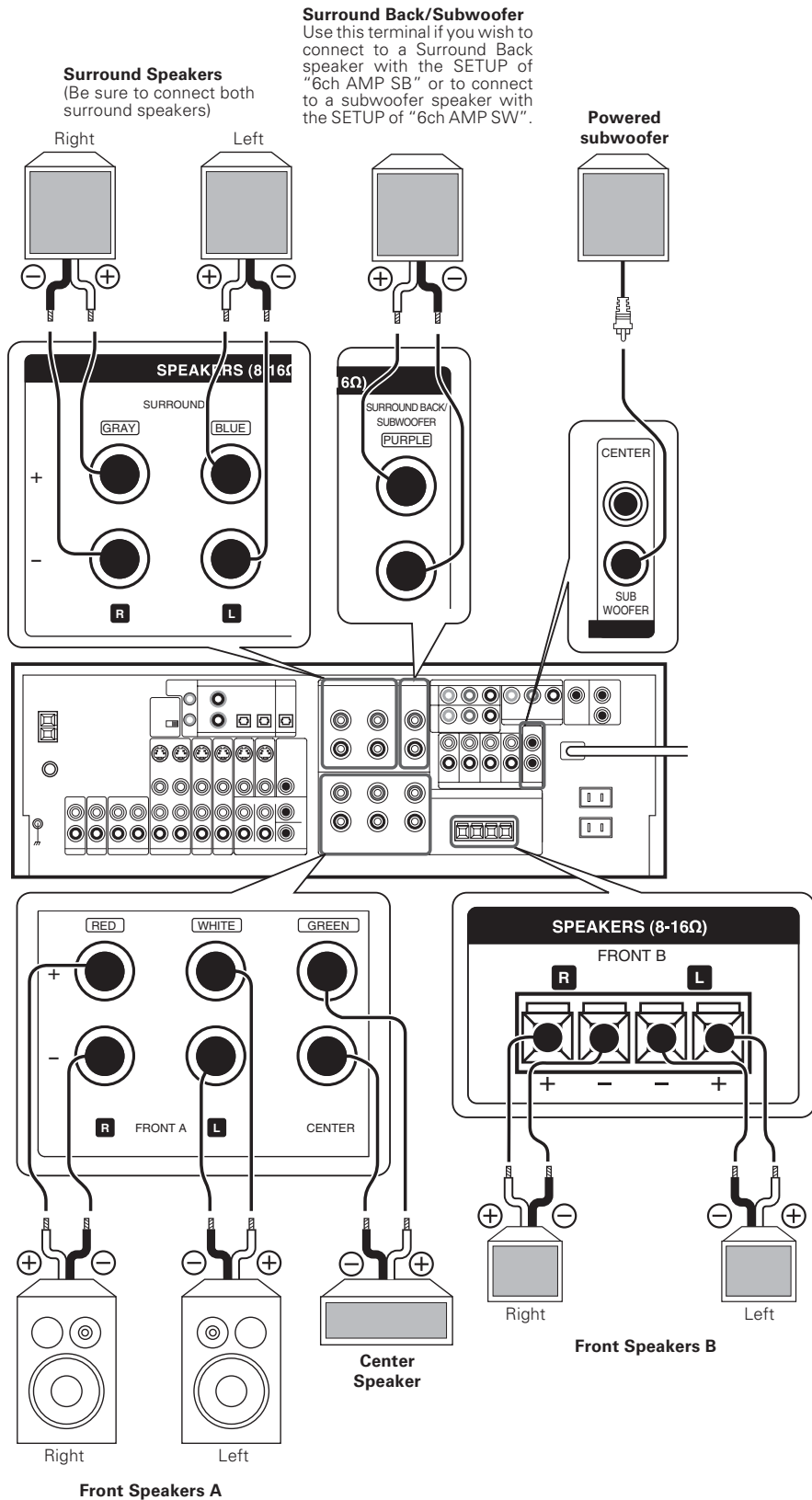

PRE OUT connections

This receiver has additional PRE OUT jacks. These can be used for various purposes, but will need to be connected to an external power amplifier as shown in the example below.

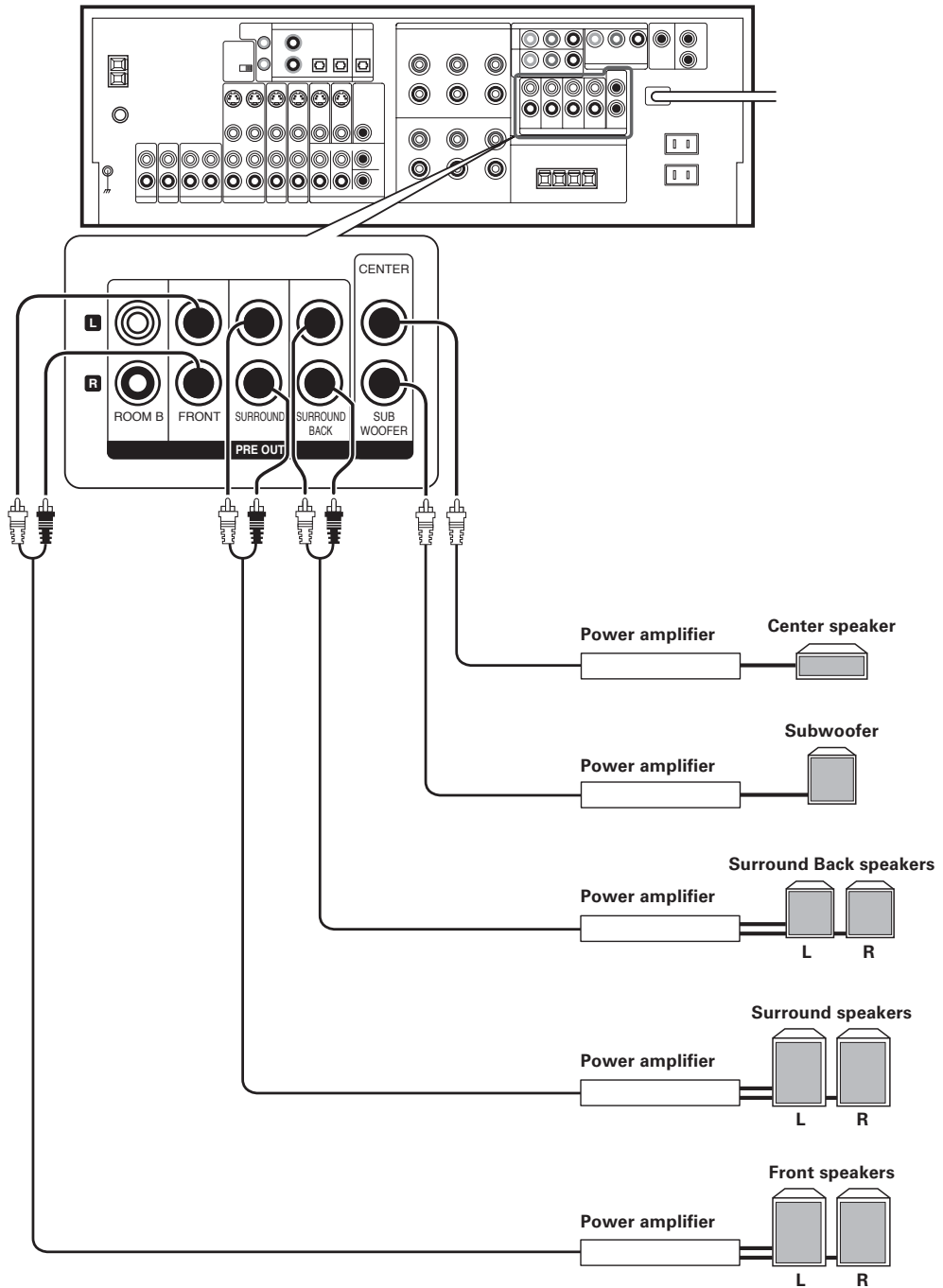

- Connecting a speaker cord directly to a **PRE OUT** jack will not produce any sound from the speaker.
- To use the **PRE OUT** jacks, press only the **SPEAKERS A** key to the ON position.
- If you choose "6ch AMP SB", sound will be heard from the **PRE OUT** Surround Back Left speaker (monaural) only.
- This connection is available for listening in ROOM B.

Connecting to another room (ROOM B)

This connection allows you to connect your main system to a monitor TV and speaker system located in another area (ROOM B).

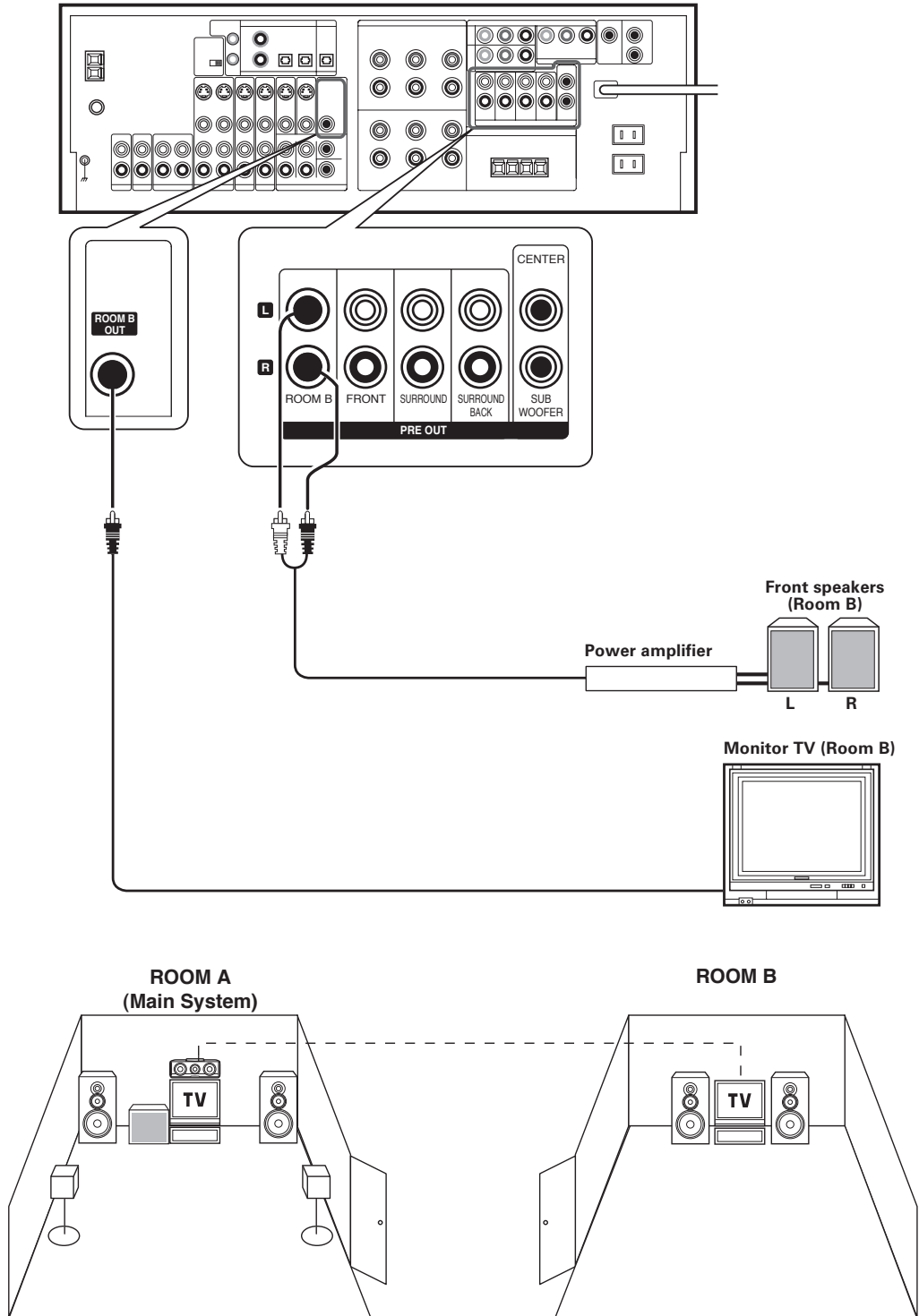

Connecting the external IR Repeater

The remote control for this receiver has the IR (infrared rays) transmission function. IR repeaters enables you to control components located in cabinets or behind glass doors. You can enjoy a wider remote control signal range by placing the IR repeater away from the receiver.

KENWOOD components (except DVD player): System control

- 22

Other components: (Registering setup codes) IR REPEATER

- 40

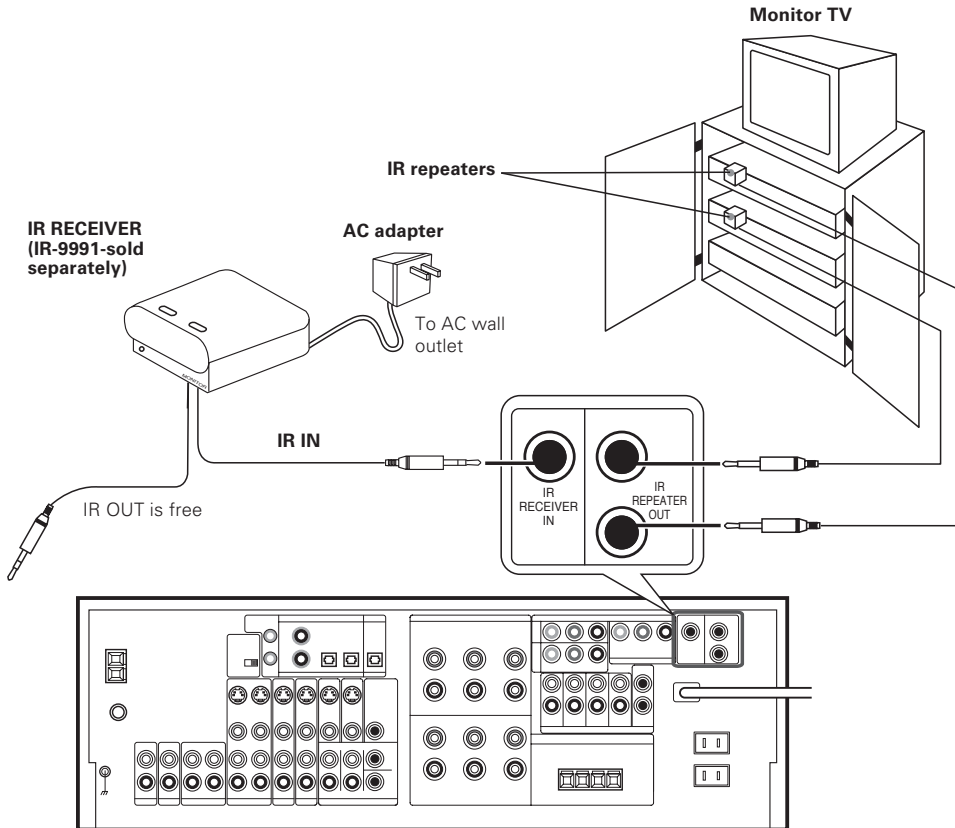

Connecting IR repeater

- 1 Connect the IR repeater to the device as described in the repeater's manual.
- 2 Connect the IR repeater cable(s) to the IR REPEATER OUT jack(s).

Notes

- IR repeaters send a signal similar to the device's own remote control. Xantech repeaters (models 282-00, 286-00, or 283-00) are compatible with your new audio-video receiver.

Shape of plug to be connected.

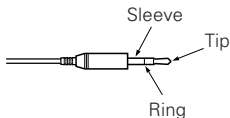
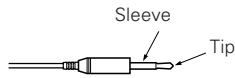
	IR RECEIVER IN	IR REPEATER OUT
	Stereo mini plug	Mono mini plug
		
IR IN / OUT SPECIFICATION:		
Terminal	IR RECEIVER IN	IR REPEATER OUT
To Tip	Signal	Signal
To Ring	Ground	
To Sleeve	+ 8V	Ground

Connecting to the AV AUX jacks

The AV AUX jacks are convenient for connection of video components such as a camcorder or a video game.

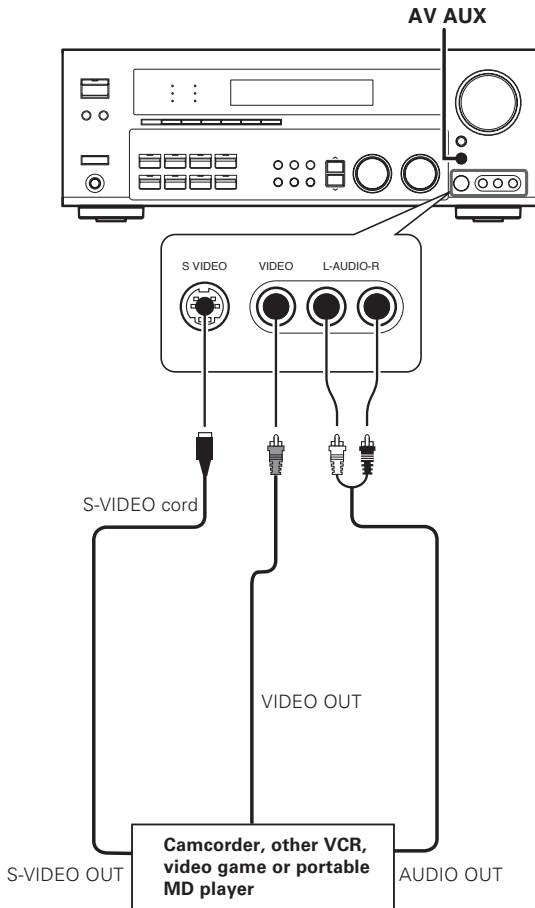

- To select the source connected to the AV AUX jacks press AV AUX key. → 26
- When you connect the audio source such as the MD player, you do not need to connect the video cable.
- When you connect the unit and the component with the S-VIDEO cord, you can get better picture quality.

Connecting the antennas

AM loop antenna

The supplied loop antenna is for indoor use. Place it as far as possible from the receiver, TV set, speaker cords and power cord, and adjust the direction for best reception.

AM antenna terminal connections

① Push lever.

② Insert cord.

③ Release lever.

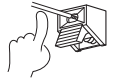
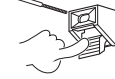
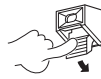

FM indoor antenna

The supplied indoor antenna is for temporary use only. For stable signal reception we recommend using an outdoor antenna. Disconnect the indoor antenna when you connect one outdoors.

FM antenna terminal connections

Insert cord.



FM outdoor antenna

Lead the 75Ω coaxial cable connected to the FM outdoor antenna into the room and connect it to the **FM 75Ω** terminal.

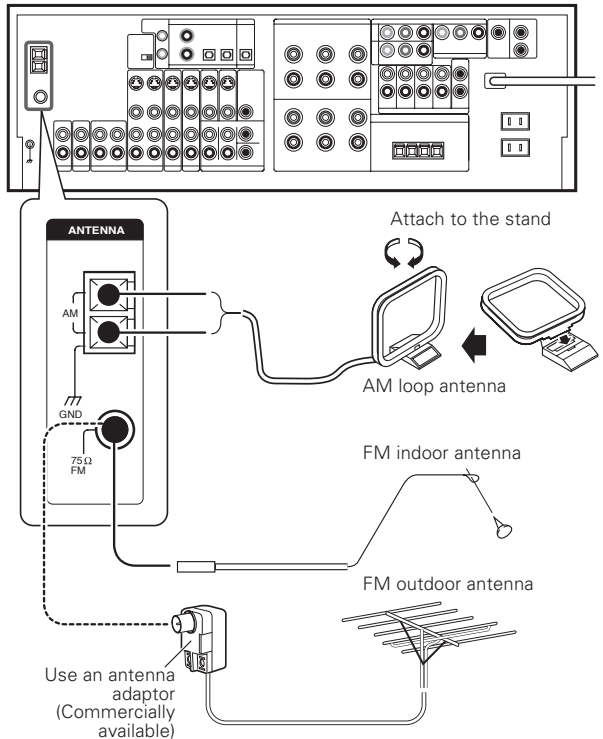

Connecting the system control

Connecting system control cords after connecting a KENWOOD audio component system lets you take advantage of convenient system control operations.

This unit is compatible only with the [SL-16] mode. The system control operation is not available if the unit is connected in the [XS8], [XS], or [XR] connection mode.

If your component has the mode select switch, set the connected components to the [SL16] mode.

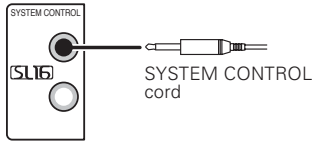

- You may connect the system control cord to either the up or down jack.

EXAMPLE: [SL16] mode connections

The underlined portion represents the setting of the system control mode.

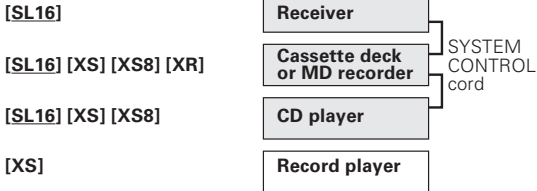

- In order to take advantage of the system control operations, the components must be connected to the correct jacks. To use a CD player it must be connected to the CD jacks. To use a cassette deck (or MD recorder) it must be connected to the MD/TAPE jacks. When using more than one CD player (etc.) only the one connected to the specified jacks may be connected for system control.
- Some CD players and cassette decks are not compatible with the [SL16] system control mode. Do not make system connections with equipment that is not [SL16] compatible.
- Some MD players are not system control compatible. You cannot make system control connections to this kind of equipment.

Notes

- [SL16] equipment cannot be combined with [XR], [XS], and [XS8] equipment for system operations. If your equipment consists of this kind of combination, please do not connect any system control cords. Even without system control cords, normal operations can be carried out without effecting performance.
- Do not connect system control cords to any components other than those specified by KENWOOD. It may cause a malfunction and damage your equipment.
- Be sure the system control plugs are inserted all the way in to the system control terminals.

SYSTEM CONTROL OPERATIONS

Remote Control

Lets you operate this unit with the system remote supplied with the receiver.

Automatic Operation

When you start playback from a source component, the input selector on this unit switches to that component automatically.

Synchronized Recording

Lets you synchronize recording with the start of playback when recording from CD, MD or analog discs.

Registering setup codes for KENWOOD audio components

If you own remote controllable KENWOOD audio components that are not compatible with system control, registering the setup code enables you to control those components using the remote control supplied with this unit (without connecting system control cords). To register setup codes for your remote controllable KENWOOD audio components, see "Registering setup codes for other components".

- 40

Preparing for surround sound

Speaker settings

To enable you to obtain optimum enjoyment from the receiver's listening modes, make sure to complete the speaker settings (subwoofer, front, center, and surround speakers) as described below.

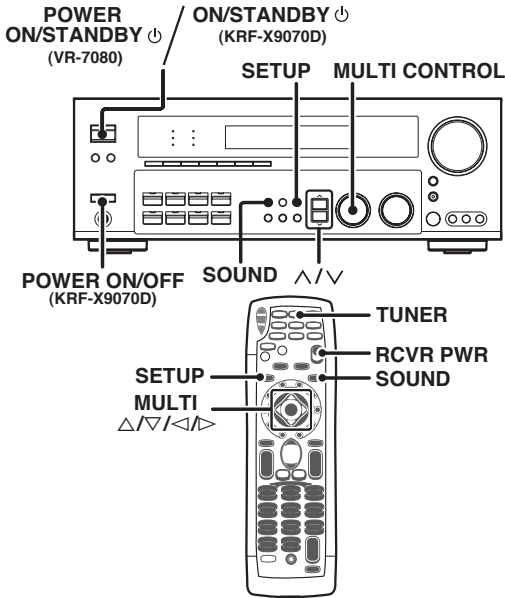

1 Turn on the power to this receiver by pressing the POWER ON/STANDBY key or RCVR PWR key.

- When you use the remote control, press the **SUB** key to switch to sub screen mode.

2 Press the SETUP key to enter the SETUP mode.

The Surround Back and Subwoofer speaker output selections are displayed as follows:

- ➔ ① **6ch AMP SB** : Surround Back/Subwoofer speaker terminal will output SB sound. Surround Back pre out will have output from SBL only.
- ➔ ② **6ch AMP SW** : Surround Back/Subwoofer speaker terminal will output SW sound. Surround Back pre out will have output from SBL and SBR.
- ➔ ③ **6ch AMP OFF** : It is not advisable to use Surround Back/Subwoofer speaker terminal for this selection.

Use the **MULTI CONTROL** knob or **MULTI** Δ/∇ keys to select the speakers.
Press the **SETUP** key to proceed to the next SETUP selection.

Use Δ/∇ keys or **MULTI** $\triangleleft/\triangleright$ keys for the following displays.

- ➔ ① **SP SETUP**
- ➔ ② **TEST TONE**
- ➔ ③ **BASS PEAK**
- ➔ ④ **SP DISTANCE**
- ➔ ⑤ **DISP MODE**
- ➔ ⑥ **EXIT**

The flow of the SETUP is as follows:

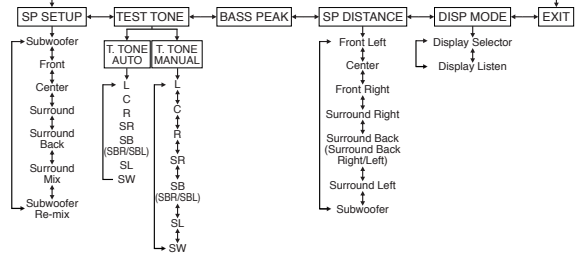

3 Select a speaker system.

If you have THX certified speakers, please set them to NML/THX.

- ➔ ① **Select the SP SETUP and press the SETUP key again so that the subwoofer setting indication "SUBW ON" appears.**

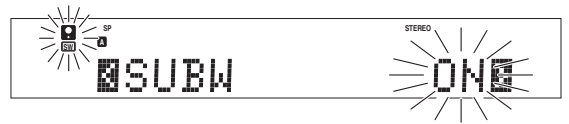

- ➔ ② **Use the MULTI CONTROL knob or MULTI Δ/∇ keys to select the appropriate subwoofer setting.**

- ➔ ① **SUBW ON** : Subwoofer setting mode to the receiver is ON.
- ➔ ② **SUBW OFF** : Subwoofer setting mode to the receiver is OFF.

- The initial setting is "SUBW ON".
- When the setting "SUBW OFF" is selected, the front speakers are automatically set to "FRNT LARGE" and the procedure skips to step ④.
- Before step ④, press the **SETUP** key to accept the setting.
- When subwoofer output sound is required, select "FRNT NML/THX", or select both "FRNT LARGE" and "SW RE-MIX ON".
- After setting SW (subwoofer) from OFF to ON, 6ch AMP setup display will appear to enable you to re-select either SW, SB or OFF from the surround back or subwoofer speaker terminal.

- ➔ ③ **Press the Δ key or MULTI \triangleright key to accept the setting.**
 - The front speakers setting indication "FRNT" appears.

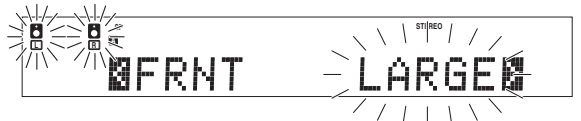

- ➔ ④ **Use the MULTI CONTROL knob or MULTI Δ/∇ keys to select the appropriate front speakers setting.**

- ➔ ① **FRNT LARGE** : Large front speakers are connected to the receiver.
- ➔ ② **FRNT NML/THX** : Average size front speakers are connected to the receiver.

- For "FRNT LARGE" selection, no sound will be heard from subwoofer speaker even when it is set to on. However, if you select "SW RE-MIX ON" when subwoofer is selected, you will be able to hear sound from the subwoofer. When in STEREO mode, the sound goes directly to front speaker.

- ➔ ⑤ **Press the Δ key or MULTI \triangleright key to accept the setting.**
 - The center speaker setting indication "CNTR" appears.

- 6 Use the MULTI CONTROL knob or MULTI Δ/∇ keys to select the appropriate center speaker setting.

If you selected "LARGE" as the front speakers setting,

- 1 CNTR LARGE : A large center speaker is connected to the receiver.
- 2 CNTR NML/THX : An average size center speaker is connected to the receiver.
- 3 CNTR OFF : Center speaker setting mode to the receiver is OFF.

If you selected "NML/THX" as the front speakers setting,

- 1 CNTR NML/THX : Center speaker setting mode to the receiver is ON.
- 2 CNTR OFF : Center speaker setting mode to the receiver is OFF.

- 7 Press the \wedge key or MULTI \triangleright key again to accept the setting.
 - The surround speaker setting indication "SURR" appears.

- 8 Use the MULTI CONTROL knob or MULTI Δ/∇ keys to select the appropriate surround speaker setting.

If you selected "LARGE" as the center speaker setting,

- 1 SURR LARGE : Large surround speakers are connected to the receiver.
- 2 SURR NML/THX : Average size surround speakers are connected to the receiver.
- 3 SURR OFF : Surround speaker setting mode to the receiver is OFF.

If you selected other than "LARGE" as the center speaker setting,

- 1 SURR NML/THX : Surround speaker setting mode to the receiver is ON.
- 2 SURR OFF : Surround speaker setting mode to the receiver is OFF.

- When the setting "SURR OFF" is selected, the procedure skips to step 10.

- 9 Press the \wedge key or MULTI \triangleright key again to accept the setting.
 - The surround back speaker setting indication "SB" appears.

- 10 Use the MULTI CONTROL knob or MULTI Δ/∇ keys to select appropriate surround back speaker setting.

If you selected "LARGE" as the surround speaker setting,

- 1 SB NML/THX : Average size surround back speaker is connected to the receiver.
- 2 SB LARGE : Large surround back speaker is connected to the receiver.
- 3 SB OFF : Surround back speaker setting mode to the receiver is OFF.

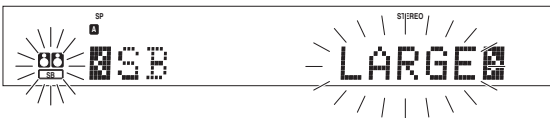

If you selected "NML/THX" as the surround speaker setting,

- 1 SB NML/THX : Surround back speaker setting mode to the receiver is ON.
- 2 SB OFF : Surround back speaker setting mode to the receiver is OFF.

- After setting SB (surround back) from OFF to NML/THX, 6ch AMP setup display will appear to enable you to re-select either SW, SB or OFF from the surround back or subwoofer speaker terminal.

- 11 Press the \wedge key or MULTI \triangleright key again to accept the setting and "SURR:MIX" appears.
 - "SURR:MIX" is when the SL and SR speakers signals are mixed to produce sound from the surround back speaker which would enable the listener to enjoy sound coming from the back.

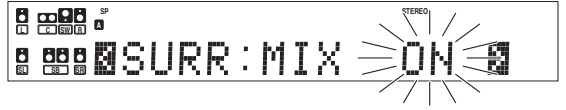

- 12 Use the MULTI CONTROL knob or MULTI Δ/∇ keys to select the following.

- 1 SURR:MIX ON : Surround mix setting mode to the receiver is ON.
- 2 SURR:MIX OFF : Surround mix setting mode to the receiver is OFF.

- If surround back speaker is turned off, SURR:MIX setting is not visible and the procedure skips to step 15.

- 13 Press the \wedge key or MULTI \triangleright key again to accept the setting.
 - The subwoofer re-mix setting indication "SW RE-MIX" appears.

- 14 Use the MULTI CONTROL knob or MULTI Δ/∇ keys to select the appropriate subwoofer re-mix setting.

- 1 SW RE-MIX ON : Subwoofer re-mix setting mode to the receiver is ON.
- 2 SW RE-MIX OFF : Subwoofer re-mix setting mode to the receiver is OFF.

- If subwoofer is turned off, subwoofer re-mix setting is not visible.

- 15 Press the SETUP key again to return to the main setup displays.

- The receiver enters the speaker volume level adjustment mode.
- In steps 4 and 5, indications appear only for the selected channels of the speakers that require adjusting.

4 Adjust the speaker volume level.

From your usual listening position, adjust the volume levels. Using a handheld SPL meter at arms length from your body, adjust the noise to read 75dB when set to "C" weighting, "Slow" reading on the meter. If you do not have an SPL meter, adjust the volume levels so that the speakers sound about the same level, starting at the 0dB setting on the display.

- 1 Press the \wedge/∇ keys or MULTI $\triangleleft/\triangleright$ keys to select TEST TONE.

- 2 Press the SETUP key for the following displays:

- 1 T.TONE AUTO
- 2 T.TONE MANUAL

- 3 The selection of AUTO/MANUAL TEST TONE is done by the MULTI CONTROL knob or MULTI Δ/∇ keys. Press the SETUP key again to begin TEST TONE.

Use the MULTI CONTROL knob or MULTI Δ/∇ keys to adjust the volume level of the test tone output from the speaker channel to be adjusted.

For AUTO selection, the first test tone is heard from the front left speaker for 2.5 seconds. The next test tone is heard from the speakers in the following sequence for 2 seconds each.

When the 6ch AMP SB has been selected.

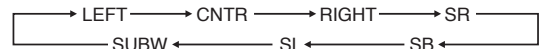

When the 6ch AMP SW or OFF has been selected.

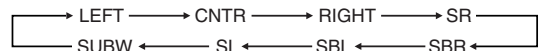

The channel indication blinks while the test tone is being output.



- If you change the volume level settings for the speakers while listening to music, the settings referred to on this page are also changed. → [37]
- If any of the speaker is set as OFF during SP SETUP, the TEST TONE adjustment for the speaker will be skipped.

For MANUAL selection, press the \wedge/\vee keys or MULTI $\triangleleft/\triangleright$ keys each time to select the speaker channel.

- Press the SETUP key again.
 - The test tone is turned off and return to the main setup displays.

5 Adjust the bass peak level.

A restriction is put on the low frequency so that the bass peak level will not go higher than the acceptable level when the volume is increased.

If subwoofer speaker is OFF, the limitation will affect the low frequency of the front left and right speakers

- Press the \wedge/\vee keys or MULTI $\triangleleft/\triangleright$ keys to select BASS PEAK and press the SETUP key.

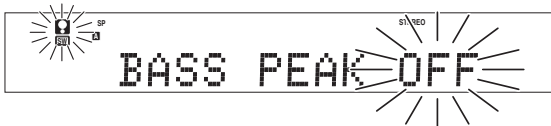

- Use the MULTI CONTROL knob or MULTI \triangle/∇ keys to adjust the bass peak level to -30dB.
 - The adjustment range is from -30dB to 0dB and OFF.

- For optimum bass peak level, keep increasing the bass peak level by using the MULTI CONTROL knob or or MULTI \triangle/∇ keys while test tone is being output until clip sound is heard from the subwoofer or front speaker.

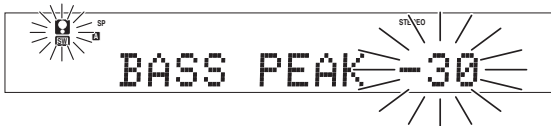

- Press the SETUP key to accept the setting.

6 Input the distance to the speakers.

- Press the \wedge/\vee keys or MULTI $\triangleleft/\triangleright$ keys to select the SP DISTANCE on setup displays and press the SETUP key again.

- Measure the distance from the listening position to each of the speakers.

jot down the distance to each of the speakers.

- Distance to Front left speaker (L) : ___ feet (meters)
- Distance to Center speaker (C) : ___ feet (meters)
- Distance to Front right speaker (R) : ___ feet (meters)
- Distance to Surround right (SR) : ___ feet (meters)
- Distance to Surround back right (SBR) : ___ feet (meters)
- Distance to Surround back left (SBL) : ___ feet (meters)
- Distance to Surround back (SB) : ___ feet (meters)
- Distance to Surround left (SL) : ___ feet (meters)
- Distance to Subwoofer (SW) : ___ feet (meters)

- Use the \wedge/\vee keys or MULTI $\triangleleft/\triangleright$ keys to select the speakers and the MULTI CONTROL knob or MULTI \triangle/∇ keys to adjust the distance to the front speakers.

The speaker indicator to be adjusted blinks.



Indication in feet Indication in meters

- The allowable setting range is 1 to 30 feet (0.3 to 9.0 m), adjustable in 1 foot (0.3 m) increments.

- Repeat steps 2 to input the distance for each of the speakers.

- Press the SETUP key again to return to main setup displays.
 - The speakers you have selected should appear on the display. Confirm that all the speakers have been currently selected.

7 Select the display mode.

- Press the \wedge/\vee key or MULTI $\triangleleft/\triangleright$ keys to select the DISP MODE.

- Press the SETUP key for the following displays:

- ① DISP SELECTOR : Displays the current input selector.
- ② DISP LISTEN : Displays the current listen mode.

- Use the MULTI CONTROL knob or MULTI \triangle/∇ keys to select the display mode.



- Press the SETUP key again to accept the setting.

- Use the \wedge key or MULTI \triangleright key to select EXIT.



- Press the SETUP key to exit the SETUP mode.

Input level adjustment (analog sources only)

If the input level of an analog source signal is too high, the CLIP indicator will blink to indicate the source signal. Adjust the input level.



- Use the Input Selector keys to select the source of which the input level you want to adjust.
 - You can store a separate input level for each input source.

- Press the SOUND and \wedge/\vee keys or MULTI $\triangleleft/\triangleright$ keys repeatedly until the "INPUT" indication appears.

- Use the MULTI CONTROL knob or MULTI \triangle/∇ keys to adjust the input level.



- The adjustment mode is displayed for approximately 8 seconds.
- The input level may be adjusted to any one of three settings: 0dB, -3dB, and -6dB. (The initial setting is 0dB.)

- Press the SOUND key again to return to the input indication.

Normal playback

Preparing for playback

Some preparatory steps are needed before starting playback.

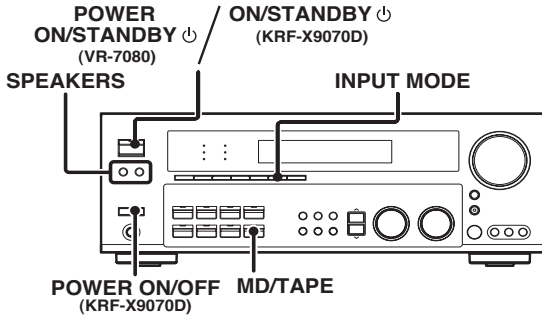

Turning on the receiver

- 1 Turn on the power to the related components.
- 2 Turn on the power to this receiver by pressing the **POWER ON/STANDBY** key.

Selecting the input mode

If you have selected a component connected to the **CD/DVD, VIDEO 2, VIDEO 3** or **DVD/6CH** jacks, make sure that the input mode setting is correct for the type of audio signal to be used. 

Selecting MD/TAPE

Select the source name corresponding to the component connected to the MD/TAPE jacks. The initial factory setting is "TAPE". To change the source to "MD", follow the steps below:

Hold down the MD/TAPE key for more than 2 seconds.

- The source indication changes to "MD".
- To return to the original indication, repeat the above procedure.

Selecting the speaker system

Press the **SPEAKERS** key to select the speaker system to be used.

- A ON** : Sound from the speakers connected to the **SPEAKERS A** terminals on the rear panel.
- B ON** : Sound from the speakers connected to the **SPEAKERS B** terminals on the rear panel. No sound will be heard from the subwoofer.
- A+B ON** : Sound from both the speakers connected to the **SPEAKERS A** and **B** terminals on the rear panel.
- A+B OFF** : No sound from the speakers. Use this setting when listening with headphones for stereo sound in all playback modes. The display segments are different depending on the type of input signal.

The indicator for the speakers you want to use should be lit.

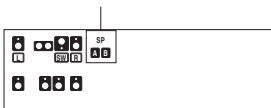

- Selecting "6CH INPUT" by pressing the **INPUT MODE** key, whereby "DVD/6CH" is the input source will cause **SPEAKERS A** to be selected automatically.

Listening to a source component

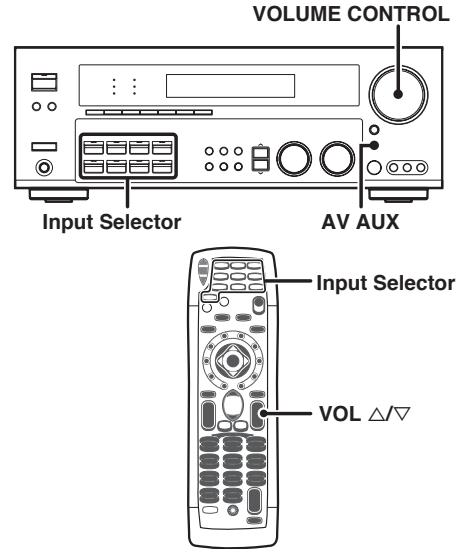

- 1 Use the **Input Selector** and **AV AUX** key to select the source you want to listen to.

Selecting a source using each key.

- ① "DVD/6CH"
- ② "CD/DVD"
- ③ "PHONO"
- ④ "TUNER"
- ⑤ "VIDEO 1"
- ⑥ "VIDEO 2"
- ⑦ "VIDEO 3"
- ⑧ "MD/TAPE"
- ⑨ "AV AUX"

- 2 Start playback from the selected source.

- 3 Use the **VOLUME CONTROL** knob or **VOL Δ/∇** keys to adjust the volume.

Adjusting the sound

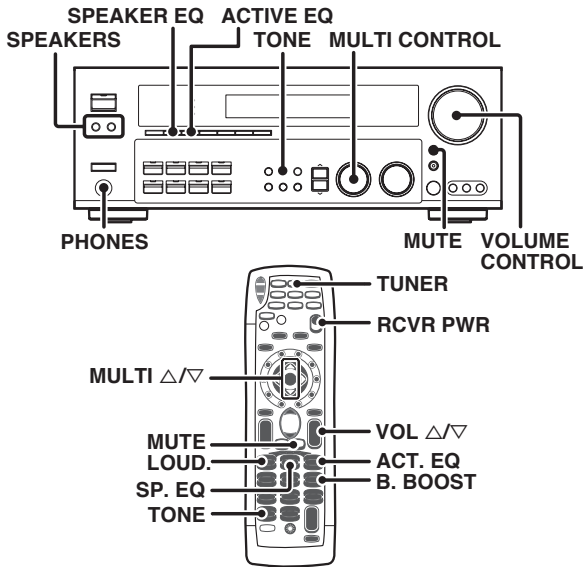

Adjusting the TONE

You can adjust the sound quality when the receiver is in the PCM stereo mode, analog stereo mode and when "THX OFF".

- For the remote control, press and hold the TUNER key for more than 3 seconds to switch to receiver mode.
 - When you use the remote control, press the SUB key to switch to sub screen mode.
- Use the MULTI CONTROL knob or MULTI Δ/∇ keys to select TONE ON/OFF.

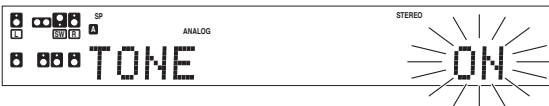

- When in TONE ON selection, press the TONE key for the following displays.

BASS : Select this to adjust the low frequency range.
TREBLE : Select this to adjust the high frequency range.

- Use the MULTI CONTROL knob or MULTI Δ/∇ keys to adjust the sound quality.



- The bass and treble levels are adjustable from -10 to +10 in 2 step increments.
- The adjustment item is displayed for approximately 8 seconds.

Once-touch low frequency emphasis (Bass Boost) (remote control only)

You can adjust the sound quality when the receiver is in the PCM stereo mode, analog stereo mode and when "THX OFF".

Press the B. BOOST key.

- Press the key once to select the maximum (+10) low frequency emphasis setting.
- This key does not function when the receiver is in the sound quality or ambience effects adjustment mode.

Switching back to the previous setting

Press the B. BOOST key again.

Adjusting the LOUDNESS mode (remote control only)

You can adjust the Loudness function which controls the low volume settings to maintain the music's richness. The adjustment can be made when the receiver is in the PCM stereo mode, analog stereo mode and when "THX OFF".

Press the LOUD. key to turn the LOUDNESS setting ON.

To cancel

Press the LOUD. key again so that the "LOUDNESS" indicator goes off.

Muting the sound

The MUTE key lets you mute the sound of the speakers.

Press the MUTE key.

Blinks

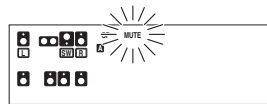

To cancel

Press the MUTE key again so that the "MUTE" indicator goes off.

- MUTE ON can also be deactivated by turning the VOLUME CONTROL knob or pressing VOL Δ/∇ keys.

ACTIVE EQ mode

You can enjoy a more impressive sound effect when ACTIVE EQ is turned ON during Dolby Digital and DTS playback and, when in PCM and analog stereo mode.

Press the **ACTIVE EQ** key for the following selections;

- ① **ACTIVE EQ MUSIC** : Effective when listening to music. (The ACTIVE EQ indicator lights up.)
- ② **ACTIVE EQ CINEMA** : Effective when watching a movie. (The ACTIVE EQ indicator lights up.)
- ③ **ACTIVE EQ TV** : Effective when watching TV. (The ACTIVE EQ indicator lights up.)
- ④ **ACTIVE EQ OFF** : The ACTIVE EQ function is turned OFF. (The ACTIVE EQ indicator goes off.)

- “ACTIVE EQ” will scroll from right to left.
- When ACTIVE EQ and SPEAKER EQ are OFF and ACTIVE EQ (MUSIC) is turned ON, SPEAKER EQ (SMALL) will turn ON automatically.
- ACTIVE EQ function will not be available when REC MODE, AUTO TUNING, PRESET MEMORY or DTS-ES MATRIX is ON, and during 96kHz LPCM playback.

SPEAKER EQ mode

SPEAKER EQ function is to adjust the receiver's audio output characteristics with the speakers' characteristics which differs depending on the size of the speakers. Especially for the music sound source playback, the reproduced sound becomes more natural when adjusting the output characteristics. When activating the SPEAKER EQ function, you will be able to enjoy a more natural and dynamic sound experience even with small size speakers.

Press the **SPEAKER EQ** key to switch the following setting;

- ① **SPEAKER EQ SMALL** : To select a small size speaker. (The SPEAKER EQ indicator lights up.)
- ② **SPEAKER EQ NORMAL** : To select an average size speaker. (The SPEAKER EQ indicator lights up.)
- ③ **SPEAKER EQ LARGE** : To select a large size speaker. (The SPEAKER EQ indicator lights up.)
- ④ **SPEAKER EQ OFF** : The SPEAKER EQ function is turned OFF. (The SPEAKER EQ indicator goes off.)

- “SPEAKER EQ” will scroll from right to left.
- SPEAKER EQ cannot be turned OFF when ACTIVE EQ is turned ON.
- SPEAKER EQ function will not be available when REC MODE, AUTO TUNING, PRESET MEMORY or DTS-ES MATRIX is ON, and during 96kHz LPCM playback.

Listening with headphones

- ① Press the **A** and **B** speaker keys so that the speaker indicator goes off.

Make sure the SP indicator turns off.

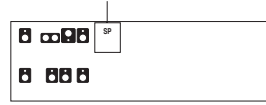

- If you turn off all of the speakers when in surround mode, the surround mode will be canceled as well, resulting in stereo playback.

- ② Connect headphones to the **PHONES** jack.

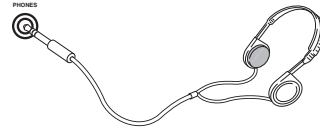

- ③ Use the **VOLUME CONTROL** knob or **VOL** Δ/∇ keys to adjust the volume.

Recording

Recording audio (analog sources)

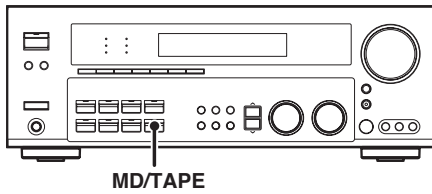

Recording a music source

- 1 Use the Input Selector keys to select the source (other than "MD/TAPE") you want to record.
- 2 Set the MD or TAPE recorder to record.
- 3 Start playback, then start recording.

Recording video

- 1 Use the Input selector keys to select the video source (other than "VIDEO 1") you want to record.
- 2 Set the video deck connected to VIDEO 1 to record.
 - Select the REC mode to record a digital input source.
- 3 Start playback, then start recording.
 - Recording may not be normal for some video software. This is due to the copy guard condition. 

Recording audio (digital sources)

Switch on the **REC mode** to record a digital input source. Usually use the **AUTO REC mode** to record audio input sources. When the digital mode changes during recording in the **AUTO REC mode**, the audio input source may be interrupted momentarily.

Recording music in AUTO REC or MANUAL REC mode

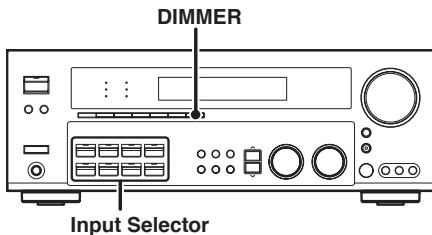

- 1 Use the Input Selector keys to select the source (CD/DVD, DVD/6CH, VIDEO 2, VIDEO 3) you want to record.
- 2 Set the MD or TAPE recorder to record.

- 3 Press and hold the DIMMER key for more than 2 seconds to select the AUTO REC or MANUAL REC mode.

- 1 **REC MODE off** : The digital input record mode is switched off.
- 2 **AUTO REC mode** : The digital input signals (DTS, Dolby Digital, or PCM) are identified automatically and converted into stereo signals that are ready for recording.
- 3 **MANUAL REC mode** : The input signal type at the moment this mode is selected is held throughout this mode.

For AUTO REC mode :



For MANUAL REC mode :



- 3 Start playback, then start recording.

- If the audio reproduction stops in the middle due to change in the input signals, etc., press the **DIMMER** key.

Listening to radio broadcasts

The receiver can store up to 40 stations in the memory and recall them by one-touch operation.

Tuning radio stations

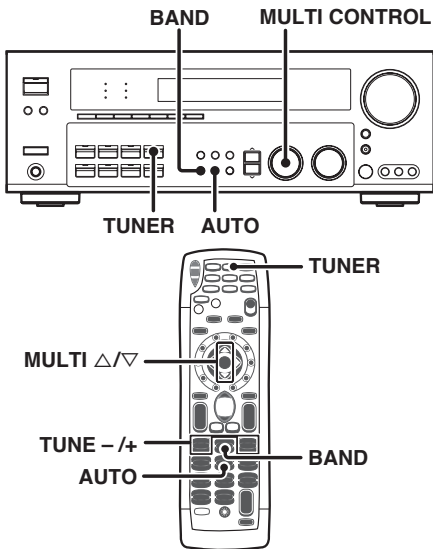

1 Use the **TUNER** key to select the tuner.

2 Use the **BAND** key to select the desired broadcast band.

Each press switches the band.



3 Use the **AUTO** key to select the desired tuning method.

Each press switches the tuning method to either auto or manual tuning.

"AUTO" indicator lights up in the display.

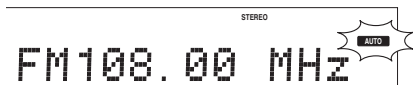

- Normally, set to "AUTO" (auto tuning). If the radio waves are weak and there is a lot of interference, switch to manual tuning. (With manual tuning, stereo broadcasts will be received in monaural.)

4 Use the **MULTI CONTROL** knob or **MULTI** Δ/∇ keys, or **TUNE** $-/+$ keys to select the station.

"STEREO" lights when a broadcast is being received in stereo.

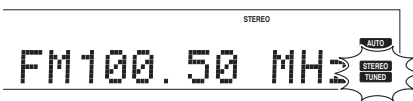

"TUNED" is displayed when a station is received.

Auto tuning : The next station is tuned automatically.

Manual tuning : Turn the **MULTI CONTROL** knob or use the **MULTI** Δ/∇ keys to select the desired station.

Presetting radio stations manually

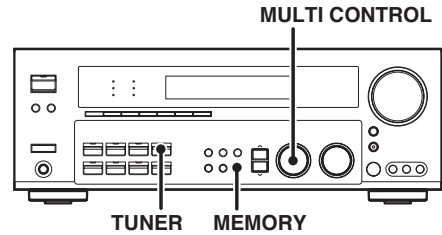

1 Tune to the station you want to store.

2 Press the **MEMORY** key while receiving the station.

Blinks for 5 seconds

Lights for 5 seconds

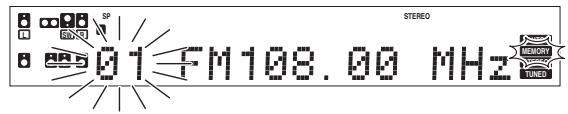

Proceed to step **3** within 5 seconds.
(If more than 5 seconds elapse, press the **MEMORY** key again).

3 Use the **MULTI CONTROL** knob to select one of the station presets (1 – 40).

4 Press the **MEMORY** key again to confirm the setting.

- Repeat steps **1**, **2**, **3** and **4** to store as many stations as necessary.
- If you store a station at a previously used preset, the old station will be replaced by the new one.

Receiving preset stations

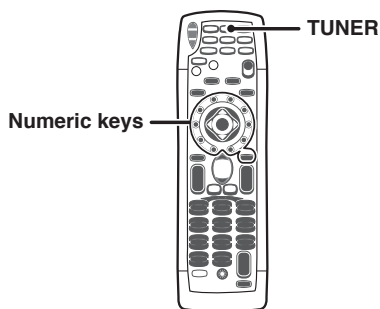

1 Press the **TUNER** key to select tuner as the source.

2 Enter the number of the preset station you want to receive (up to "40").

Press the numeric keys in the following order:

- For "15", press +10, 5
- For "20", press +10, +10, 0

• If you make a mistake entering a two digit number, press the **+10** key repeatedly to return to the original display and start again.



Receiving preset stations in order (P.CALL)

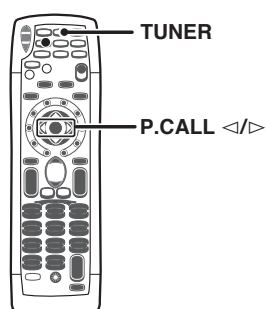

1 Press the **TUNER** key to select the tuner as the source.

2 Use the **P.CALL </>** keys to select the desired station.

- Each time you press the key, another preset station is received in order.

Pressing the P.CALL **>** does the following:

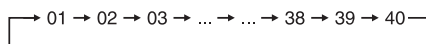

Pressing the P.CALL **<** does the following:

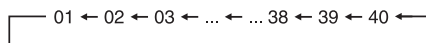

Holding down the **>** or **<** keys, lets you skip through the presets, receiving each preset station at 0.5 second intervals.

Ambience effects

This receiver is equipped with listening modes that allow you to enjoy an enhanced sonic ambience with a variety of video sources.

In order to obtain the optimum effect from the surround modes, make sure to input the proper speaker settings beforehand.

→ [23]

Surround modes

The below speaker placements are for 5.1 channel surround sound system which are;

- Dolby Digital
- Dolby Pro Logic II
- DTS
- DSP
- DVD 6-channel

The below speaker placements are for 6.1 channel surround sound system which are;

- Dolby Digital EX
- THX Surround EX
- DTS ES
- NEO : 6
- SRS Circle Surround II
- Dolby Digital, Dolby Pro logic II and DSP if "SURR MIX ON" → [24]

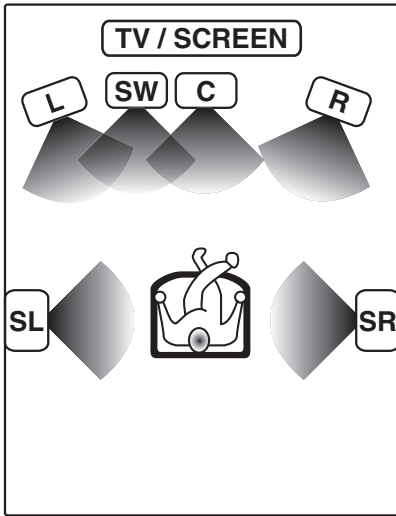

No Surround Back speaker

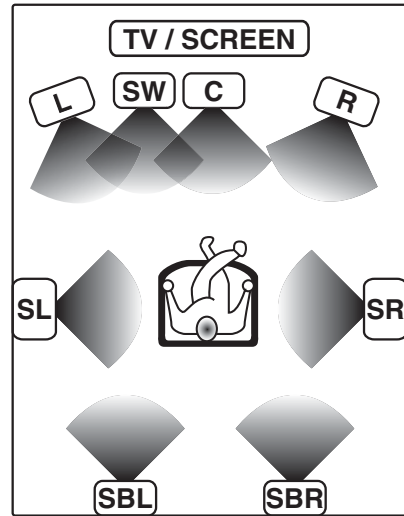

Surround Back speakers

- L** Front left speaker
- SW** Subwoofer
- C** Center speaker
- R** Front right speaker

- SR** Surround right speaker
- SBR** Surround back right speaker
- SBL** Surround back left speaker
- SL** Surround left speaker

Manufactured under license from Dolby Laboratories. "Dolby", "Pro Logic", "Surround EX" and the double-D symbol are trademarks of Dolby Laboratories.

"Circle Surround II, SRS and the (O) symbol are trademarks of SRS Labs, Inc. Circle Surround II technology is incorporated under license from SRS



Lucasfilm and THX are trademarks or registered trademarks of Lucasfilm, Ltd. ©Lucasfilm Ltd. & TM. Surround EX is a jointly developed technology of THX and Dolby Laboratories Inc. and is a trademark of Dolby Laboratories Inc. All rights reserved. Used under authorization.

"DTS", "DTS-ES Extended Surround" and "Neo:6" are registered trademarks of Digital Theater Systems, Inc.



Dolby Digital

The Dolby Digital surround format lets you enjoy up to 5.1 channels of digital surround sound from Dolby Digital program sources (such as Laserdisc or DVD software marked ). Compared with previous Dolby surround, Dolby Digital provides even better sound quality, greater spatial accuracy, and improved dynamic range.

Although a full set of speakers (front left, right, and center, surround left and right, and a subwoofer) is required for true 5.1 channel Dolby Digital surround sound, this receiver lets you enjoy Dolby Digital (and Dolby Surround) program sources, even if you connect only the front speakers.

Dolby Digital EX

Dolby Digital EX is an extension of Dolby Digital technology. Dolby Digital EX creates six full-bandwidth output channels from 6.1-channel sources. This is done using a matrix decoder that derives three surround channels from the two in the original recording. This is achieved by using three different surround signals, Left Surround, Right Surround, and Back Surround, each driving its own array of speakers. Think of it as adding a center channel for the rear speakers, which give more diffuse and natural surround effect, even if you wanted the ability to completely encircle the audience with sound, positioning sound effects exactly where they would be heard in real life. For best results, Dolby Digital EX should be used with movie soundtracks recorded with Dolby Digital Surround EX which contain a digital flag that will automatically activate this feature. However, for titles released prior to late 2001, this feature has to be activated manually.

Although a full set of speakers (front left, right, and center, surround left and right, surround back and a subwoofer) is required for true 6.1 channel Dolby Digital Surround EX sound, this receiver lets you enjoy Dolby Digital (and Dolby Surround) program sources, even if you connect only the front speakers.

Although only Dolby Digital soundtracks incorporate a separate low frequency channel, connecting a subwoofer will also improve deep bass performance in the other surround modes.

The indication "**LFE**" appears in the display when a signal is being input for this channel.

Dolby PRO LOGIC II

Dolby Pro Logic II was designed specifically to provide a new sense of spatiality, directionality and articulation of sounds from Dolby Surround encoded sources (such as video and Laserdisc software marked ). This is achieved with an intelligent, built-in feedback logic design, a matrix surround decoding and the decoding of stereo, full bandwidth surround outputs. The PRO LOGIC II modes programmed into this receiver are "MOVIE", "MUSIC" and "PRO LOGIC". The "MOVIE" mode of the PRO LOGIC II has preset characteristics to produce a calibrated, high-level surround sound playback while the "MUSIC" mode has user-adjustable characteristics to offer the three optional controls, like "Dimension", "Center Width" and "Panorama" modes to allow optimization of the soundfields as desired. The "Dimension" control allows the user to gradually adjust the soundfield either towards the front or towards the rear; the "Center Width" control allows various adjustment of the left-center-right speakers' balance; the "Panorama" mode extends the front stereo image to include the surround speakers for an exciting "wrap-around" effect with side wall imaging.

Note

LFE = Low Frequency Effects. This channel delivers separate non-directional bass signals to the subwoofer for more dynamic deep bass sound effects.

DTS

DTS (Digital Theater System) is a 5.1 channel digital audio format that provides five full spectrum channels and one low-frequency (subwoofer) channel for unprecedented clarity, optimum channel separation and a (wide) dynamic range. In the DTS mode, the 5.1 channel digital input from a DTS CD, LD or DVD disc (carrying the "DTS" marking) can be played in Digital Surround.

DTS-ES

DTS-ES (Digital Theater System-Extended Surround) presents 6.1 channels surround system with additional Surround Back channel which evolved from the conventional 5.1 channels surround system. DTS-ES format that was recorded in DVD, CD or LD comprises of two modes. DTS-ES Discrete 6.1 produce the discrete surround back which is completely independent and DTS-ES Matrix 6.1 produces the surround back which synthesised within the left and right surround channels using matrix technology. DTS-ES has perfect compatibility with the conventional 5.1 channels surround system. 6.1 channels surround with an additional surround back presents a more natural presence and surround effects by increasing the impression of the sound image from back. Programs which are recorded using DTS-ES technology consist of information flags which will be able to control the Discrete and Matrix mode. Thus, it can automatically select the best matched mode.

Neo:6

Neo:6 is a new technology which was developed by DTS. It can produce high grade 6 channels surround with an astonishing fidelity from 2 channels content. Neo:6 has 2 mode, "CINEMA" mode is for movie playback and "MUSIC" mode is for music playback.

DTS has a .1 or **LFE** channel.

The indication "**LFE**" appears in the display when a signal is being input for this channel.

SRS Circle Surround II

SRS Circle Surround II™ improves on its predecessor CS-5.1™ resulting in the CS-6.1™ system, enabling you to listen to realistic, multi-channel, surround sound playback from a stereo source or conventional surround-encoded video source. You already enjoy listening to Dolby Digital/DTS multi-channel sound with your multi-speakers. Now you can listen to audio CDs, MDs, Broadcast and Home Theater using your multi-speakers. You will discover a new type of sound through SRS Circle Surround II.

The CS system dramatically reduces storage space requirements for multi-channel content. It creates a listening environment that places the listener "inside" music performances, and dramatically improves both hi-fi audio and conventional surround-encoded video material. The CS decoder also includes the SRS technologies Focus™ and TruBass™. Focus electronically raises the sound stage from the speaker location to an optimal position. TruBass creates deep, rich bass in small speaker systems without the need for a subwoofer.

THX

Movie soundtracks are mixed in special movie theatres called dubbing stages and are designed to be played back in movie theatres with similar equipment and conditions. This same soundtrack is then transferred directly onto Laserdisc, VHS tape, DVD, etc., and is not changed for playback in a small home theatre environment.

THX engineers developed patented technologies to accurately translate the sound from the movie theatre environment into the home, correcting the tonal and spatial errors that occur. Activate THX whenever watching a movie that was intended for the playback in a Cinema. On this product, when the THX indicator is on, the following THX features are automatically added in movie playback modes (e.g. Dolby Digital+THX, DTS+THX, THX Surround EX, etc):

Re-equalization (Re-EQ)

The tonal balance of a film soundtrack will be excessively bright and harsh when played back over audio equipment in the home because film soundtracks were designed to be played back in large movie theatres using very different professional equipment. Re-Equalization restores the correct tonal balance for watching a movie soundtrack in a small home environment.

Timbre Matching

The human ear changes our perception of a sound depending on the direction from which the sound is coming. In a movie theatre, there is an array of surround speakers so that the surround information is all around you. In a home theatre, you use only two speakers located to the side of your head. The Timbre Matching feature filters the information going to the surround speakers so that they more closely match the tonal characteristics of the sound coming from the front speakers. This ensures seamless panning between the front and surround speakers.

Adaptive Decorrelation

In a movie theatre, a large number of surround speakers help create an enveloping surround sound experience, but in a home theatre there are usually only two speakers. This can make the surround speakers sound like headphones that lack spaciousness and envelopment. The surround sounds will also collapse into the closest speaker as you move away from the middle seating position. Adaptive Decorrelation slightly changes one surround channel's time and phase relationship with respect to the other surround channel. This expands the listening position and creates - with only two speakers - the same spacious surround experience as in a movie theatre.

THX Select

Before any home theatre component can be THX Select certified, it must incorporate all the features above and also pass a rigorous series of quality and performance tests. Only then can a product feature the THX Select logo. Hundreds of parameters in both the digital and analog domain are tested and required to meet very specific high quality standards which is your guarantee that the Home Theatre products you purchase will give you superb performance for many years to come. THX Select requirements cover every aspect of the product including pre-amplifier and power amplifier performance and operation.

THX Surround EX mode

THX Surround EX-Dolby Digital Surround EX is a joint development of Dolby Laboratories and the THX division of Lucasfilm Ltd.

In a movie theatre, film soundtracks that have been encoded with Dolby Digital Surround EX technology are able to reproduce an extra channel which has been added during the mixing of the program. This channel, called Surround Back, places sounds behind the listener in addition to the currently available front left, front center, front right, surround right, surround left and subwoofer channels. This additional channel provides the opportunity for more detailed imaging behind the listener and bring more depth, spacious ambience and sound localization than ever before.

Movies that were created using the Dolby Digital Surround EX technology, when released into the home consumer market may exhibit a Dolby Digital Surround EX logo on the packaging. A list of movies created using this technology can be found on the Dolby web site at <http://www.dolby.com>

Only receiver and controller product bearing the THX Surround EX logo, when in the THX Surround EX mode, faithfully reproduce this new technology in the home.

This product may also engage the "THX Surround EX" mode during the playback of 5.1 channel material that is not Dolby Digital Surround EX encoded. In such case the information delivered to the Surround Back channel will be program dependent and may or may not be very pleasing depending on the particular soundtrack and the taste of the individual listener.

DSP mode

The DSP mode lets you add the atmosphere of a live concert or hall to almost any type of program source. These modes are particularly effective when used with stereo program sources, like CD, television, and FM radio. You might enjoy trying the ARENA, JAZZ CLUB, THEATER, STADIUM or DISCO mode the next time you watch a concert or sporting event!

What's DSP?

DSP stands for Digital Signal Processor.

The way a sound is heard in an actual environment depends on a variety of different factors. One of the most important is reverberation (the act of decaying elements of sound echoing in various places). The DSP modes produce the feeling of presence by using the DSP to create reverberation, without spoiling the sound quality of the original signal.



DVD 6-channel mode

Using a DVD player or the like equipped with six (5.1) output channels and the receiver, you can enjoy multi-channel encoded DVD source material in all its splendor. Since the source signals are digital and each channel is input independently, the resulting sound quality, sense of spaciousness, and dynamic range are superb.

The indication "LFE" appears in the display during DVD 6-channel mode selection.

Surround play

The DTS compatible models can reproduce a CD, DVD, or LD carrying the DTS mark.

DOLBY DIGITAL can be used when playing DVD or LD software bearing the  mark and DOLBY DIGITAL format digital broadcasts (etc.). DOLBY PRO LOGIC can be used when playing video, DVD, or LD software bearing the  mark.

SRS Circle Surround II enables you to listen to multi channel sound from the stereo source.

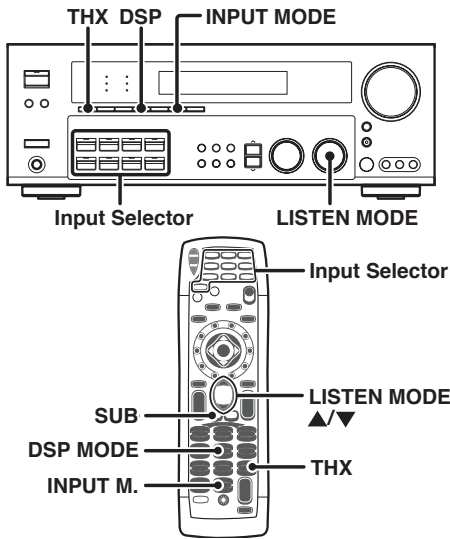

Preparations

- Turn ON related components.
- Complete "Preparing for surround sound" (speaker settings). → [23]
- Use the **Input Selector** keys to select the component you wish to play back with surround sound.
- Use the **INPUT MODE** key to select the input mode (analog or digital) for the source you wish to play back. → [10]
- Noise will be produced when a DTS source is played by selecting the analog input.

1 Start playing the video software.

- When you use the remote control, press the **SUB** key to switch to sub screen mode.

2 Use the LISTEN MODE knob or LISTEN MODE ▲/▼ keys to select the listening mode.

The listening mode settings are stored separately for each input. If the input mode is set to full auto ("AUTO DETECT" lights), the receiver selects the optimal listening mode automatically based on the type of input signal and the speaker settings.

Each turn of the LISTEN MODE knob or press of the LISTEN MODE ▲/▼ keys switches the setting as listed.

The listening mode settings are different depending on the type of input signal.

When the DOLBY DIGITAL or DOLBY DIGITAL EX signal is input :

(The DOLBY DIGITAL or PRO LOGIC, indicator lights up.)

- 1 **DOLBY DIGITAL** : DOLBY DIGITAL surround.
- 2 **DOLBY D EX** : DOLBY DIGITAL EX surround.
- 3 **PLII MOVIE** : PRO LOGIC II surround MOVIE mode. (The PRO LOGIC indicator lights up.)
- 4 **PLII MUSIC** : PRO LOGIC II surround MUSIC mode. (The PRO LOGIC indicator lights up.)
- 5 **PRO LOGIC** : PRO LOGIC II surround PRO LOGIC mode. (The PRO LOGIC indicator lights up.)
- 6 **STEREO** : Normal stereo playback.

When you select DOLBY DIGITAL

"DOLBY DIGITAL" will be displayed.



When the DTS or DTS-ES (matrix or discrete) signal is input :

- 1 **DTS** : (DTS indicator lights up.)
- 2 **DTS-ES MATRIX** : (DTS and MATRIX indicators light up.)
- 3 **DTS-ES DISCRETE** : (DTS and DISCRETE indicators light up.)
- 4 **STEREO** : Normal stereo playback.

When the analog signal or the digital signal (except for DOLBY DIGITAL or DTS signal) is input :

- 1 **PLII MOVIE** : PRO LOGIC II surround MOVIE mode. (The PRO LOGIC indicator lights up.)
- 2 **PLII MUSIC** : PRO LOGIC II surround MUSIC mode. (The PRO LOGIC indicator lights up.)
- 3 **PRO LOGIC** : PRO LOGIC II surround PRO LOGIC mode. (The PRO LOGIC indicator lights up.)
- 4 **NEO:CINEMA** : NEO:6 surround. (The NEO:6 indicator lights up.)
- 5 **NEO:MUSIC** : NEO:6 surround. (The NEO:6 indicator lights up.)
- 6 **CSII CINEMA** : CS 6.1 surround. (The CS II indicator lights up.)
- 7 **CSII MUSIC** : CS 6.1 surround. (The CS II indicator lights up.)
- 8 **CSII MONO** : CS 6.1 surround. (The CS II indicator lights up.)
- 9 **STEREO** : Normal stereo playback. (The STEREO indicator lights up.)

- Dolby Digital or DTS signal having more channels than the maximum number of playback channels available using the receiver's current settings is input, downmixing is performed to match the number of available channels.

3 DSP mode (Digital Signal Processor).

DSP can produce these effects without spoiling the sound quality of the original music or video source.

- 1 Pressing the **DSP** key or **DSP MODE** key will display the current **DSP MODE** status.

- 2 Each press of the key will switch to the next status as shown below:

- 1 **ARENA** : DSP surround ARENA mode.
- 2 **JAZZ CLUB** : DSP surround JAZZ CLUB mode.
- 3 **THEATER** : DSP surround THEATER mode.
- 4 **STADIUM** : DSP surround STADIUM mode.
- 5 **DISCO** : DSP surround DISCO mode.

- The DSP mode selection is displayed for approximately 3 seconds.

4 THX mode.

This mode creates a home theater environment which is able to reproduce a cinema surround sound system featuring improved special representation and acoustic imaging of surround channels by translating THX Surround EX technology.

Press the THX key to switch the following setting :

- ① **THX Sur EX ON** : THX Surround EX function is turned ON when Dolby Digital 5.1ch signal is detected. (THX indicator lights up.)
- ② **THX Sur EX AUTO** : THX Surround EX function is turned ON when Dolby Digital Surround EX signal is detected. (THX indicator lights up.)
- ③ **THX ON** : THX mode is turned ON. (THX indicator lights up.)
- ④ **THX OFF** : THX mode is turned OFF. (THX indicator goes off.)

- THX functions when the display segment is turned ON.
- THX Sur EX ON and THX Sur EX AUTO will not be available if surround back speakers are turned OFF.
- The THX setting differs depending on the input selector.
- When CS II, PL II MUSIC, NEO:MUSIC, ACTIVE EQ or SPEAKER EQ is ON, THX function will not be effective.

5 Adjust the volume.

Notes

- Depending on the type of the signal or speaker setting, some listening modes cannot be selected.
- When playback is started, the sound may be cut or interrupted before the input source is confirmed as Dolby Digital.
- To enjoy Dolby Digital surround (as well as all the other listening modes) from a single component, be sure to use a Dolby Digital compatible source component.
- Dialogue Normalization (Dial Norm) is a feature of Dolby Digital. It is able to automatically maintain the overall audio output level constant.



When playing some Dolby Digital sources, you may see in the display a message "DIALNORM OFFSET xxdB". This is because some soundtracks may be recorded either louder or quieter than normal. The xx number shows by how much.

For example, if the message says "DIALNORM OFFSET +4dB" you know that this particular recording was encoded 4dB louder than normal. If you wish, you can turn down the volume control by 4dB to keep the playback level consistent.

DVD 6-channel playback

Using a DVD player or the like equipped with six (5.1) output channels and the receiver, you can enjoy surround sound playback. Connecting a DVD player which can decode the surround signal itself is also acceptable.

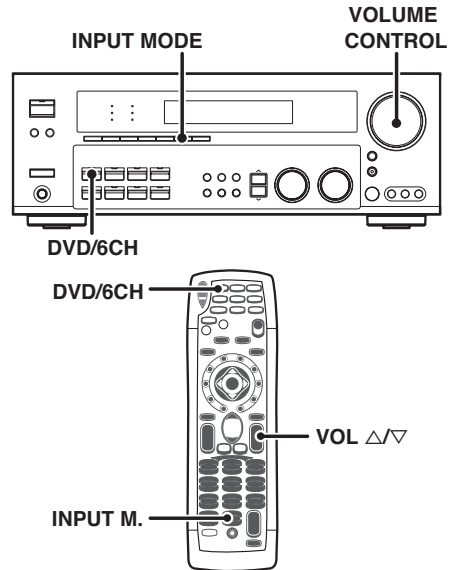

Preparations

- Connect your DVD player to the DVD/6CH jacks of the receiver.
- Turn on all other components that will be used.
- Complete "Preparing for surround sound".

- 23

1 Press "DVD/6CH" as the input source.

- When you use the remote control, press **SUB** key to switch to sub screen mode.
- If speaker system B is on when "DVD/6CH" is selected as the input source, it switches off and speaker system A turns on automatically.

2 Select "6CH INPUT" by pressing the INPUT MODE key.

3 Start playback of the DVD software.

4 Adjust the volume.

- It is not possible to adjust the volume level or sound quality (**SET UP, SOUND, LISTEN MODE, ACT. EQ and TONE key will not be functional**) of the channels separately when the receiver is in the 6CH INPUT mode. Adjust the volume with the controls of the DVD player.
For the powered subwoofer, you can adjust the volume of the subwoofer using the subwoofer's own volume control.

Convenient functions

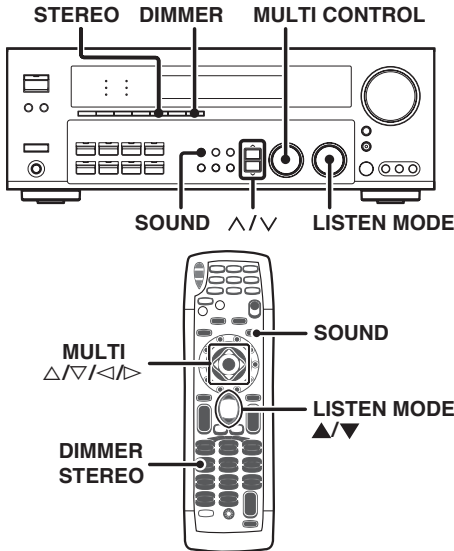

Adjusting the sound

You can make further adjustments to the sound while listening to playback in the surround mode.

- Press the **SOUND** key and then use the **^/v** keys or **MULTI** \triangle/∇ keys until the desired item appears in the display.

Each time you press the **^/v** keys or **MULTI** \triangle/∇ keys, the menu changes as follows:

Note that some items are not displayed in certain modes.

- ① CNTR (Center speaker level adjustment)*
- ② SR (Right surround speaker level adjustment)*
- ③ SBR (Surround back right speaker level adjustment)*
- ④ SBL (Surround back left speaker level adjustment)*
- ⑤ SB (Surround back speaker level adjustment)*
- ⑥ SL (Left surround speaker level adjustment)*
- ⑦ SUBW (Subwoofer level adjustment)*
- ⑧ INPUT (Input level adjustment - analog mode only) \rightarrow [25]
- ⑨ MIDNIGHT (Midnight mode ON/OFF - Dolby Digital mode only)
- ⑩ PANORAMA (Panorama mode ON/OFF)**
- ⑪ DIMENSION (Dimension adjustment)**
- ⑫ CENTER WIDTH (Center Width adjustment)**
- ⑬ CENTER FOCUS (Center Focus adjustment)***
- ⑭ CSII DLY (Rear Delay adjustment)***
- ⑮ CSII GAIN (Input gain adjustment)***
- ⑯ TruBass (Trubass adjustment)***

* The adjustment is only temporary for the current input selection. The value will return automatically to the original setup value when the power is turned on/off or when the input selection is changed.

** Pro Logic II Music mode only.

*** CS II mode only.

- Use the **MULTI CONTROL** knob or **MULTI** \triangle/∇ keys to adjust the setting as desired.

•The adjustment item is displayed for approximately 8 seconds.

Midnight mode (Dolby Digital mode only)

When watching movies at night, you might not be able to raise the volume as loud as normal. Midnight mode compresses the dynamic range of previously specified heavy sound passage of the Dolby Digital sound track (like scenes with sudden increases in volume) to minimize the difference in volume between the scenes with heavy sound passage and scenes with normal sound passage. This makes it easy to hear all of the sound track, even when listening at low volumes.

- Press the **SOUND** key, then press the **^/v** keys or **MULTI** \triangle/∇ keys until "MIDNIGHT" appears on the display.

• This can be selected only if CD/DVD, DVD/6CH, VIDEO 2 or VIDEO 3 is selected as the source and the listen mode is set to "DOLBY DIGITAL."

- Use the **MULTI CONTROL** knob or **MULTI** \triangle/∇ keys to select the ON or OFF setting.



- The adjustment item is displayed for approximately 8 seconds.
- Some Dolby Digital software may not be compatible with the Midnight mode.

Panorama mode (Pro Logic II Music mode only)

When listening to music, you will be able to enjoy the "wrap-around" sound effect when you adjust the panorama setting.

- Press the **SOUND** key, then press the **^/v** keys or **MULTI** \triangle/∇ keys until "PANORAMA" appears on the display.

- Use the **MULTI CONTROL** knob or **MULTI** \triangle/∇ keys to select PANORAMA ON or OFF.

① PANORAMA ON : PANORAMA mode is ON.

② PANORAMA OFF : PANORAMA mode is OFF.



Dimension mode (Pro Logic II Music mode only)

When listening to music with certain recordings, you will also be able to achieve a suitable balance from all the speakers by adjusting the dimension mode.

- 1 Press the **SOUND** key, then press the **▲/▼** keys or **MULTI </>** keys until "DIMENSION" appears on the display.
- 2 Use the **MULTI CONTROL** knob or **MULTI ▲/▼** keys to adjust the soundfield towards the rear or the front.

Soundfield is adjusted towards the front.

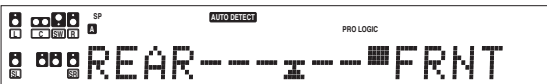

Soundfield is in neutral position.

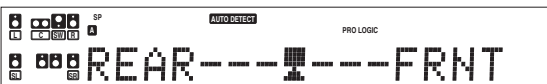

Soundfield is adjusted towards the rear.

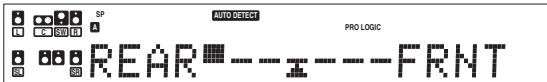

Center Width mode (Pro Logic II Music mode only)

Center width adjustment allows you to enjoy an enhanced sound when listening to music through center image from only center speaker, or left and right speakers or various combinations adjustments.

- 1 Press the **SOUND** key, then press the **▲/▼** keys or **MULTI </>** keys until "CENTER WIDTH" appears on the display.
 - The CENTER WIDTH indication scrolls across the display.
 - When the center speaker is switched OFF, this mode will not be effective.
- 2 Use the **MULTI CONTROL** knob or **MULTI ▲/▼** keys to adjust the left-center-right output.

Center image will be heard from center speaker only.

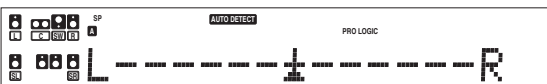

Center image will be heard from left and right speakers only.

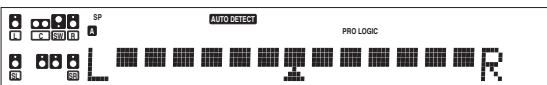

- When in other position, center image from center speaker, left and right speakers can be heard simultaneously with various combinations.

Circle Surround II mode

When you select the Circle Surround II mode, you will be able to enjoy the multi surround sound from the stereo source.

Use the **LISTEN MODE** knob or **LISTEN MODE ▲/▼** keys for CS II selection.

Center Focus mode (CS II mode only)

Center focus elevate level adjustment allows you to enjoy an enhanced sound when you select CS II CINEMA/MUSIC/MONO. It repositions the sound image to an optimal position more natural to the listener through the center image.

- 1 Press the **SOUND** key, then press the **▲/▼** keys or **MULTI </>** keys until "CENTER FOCUS" appears on the display.

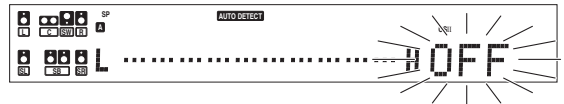

- 2 Use the **MULTI CONTROL** knob or **MULTI ▲/▼** keys to adjust the center elevation level.
 - The adjustment range is from 0 to 10.

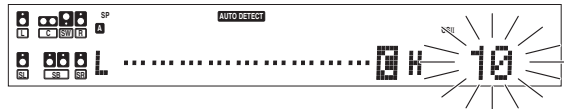

- CENTER FOCUS will not be available when the center speaker is OFF.

CS II Rear Delay adjustment mode (CS II mode only)

CS II Rear Delay adjustment provides a better sound effect from the rear speakers.

- 1 Press the **SOUND** key, then press the **▲/▼** keys or **MULTI </>** keys until "CSII DLY" appears on the display.
- 2 Use the **MULTI CONTROL** knob or **MULTI ▲/▼** keys to adjust the rear speaker.
 - The adjustment range is from 0 ms to 25 ms.

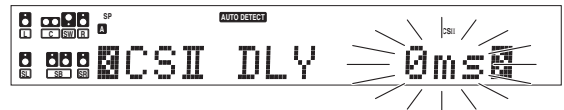

CS II Gain adjustment mode (CS II mode only)

CS II GAIN allows user to adjust the input gain for the Circle Surround II processing.

- ➊ Press the **SOUND** key, then press the **▲/▼** keys or **MULTI** **◀/▶** keys until "CSII GAIN" appears on the display.
- ➋ Use the **MULTI CONTROL** knob or **MULTI** **△/▽** keys to adjust the input gain.

- The adjustment range is from 0 to -18.



TruBass adjustment mode (CS II mode only)

TruBass adjustment provides deep, rich bass sound to various speakers.

- ➊ Press the **SOUND** key, then press the **▲/▼** keys or **MULTI** **◀/▶** keys until "TruBass" appears.
- ➋ Use the **MULTI CONTROL** knob or **MULTI** **△/▽** keys to select the following;

- ➊ TruBass OFF
- ➋ TruBass SW
- ➌ TruBass LR
- ➍ TruBass SW + LR

- After selecting ➋, ➌ or ➍, TruBass speaker size and level adjustment selection will be available.

- ➌ For TruBass speaker selection, use the **MULTI CONTROL** knob or **MULTI** **△/▽** keys to select any of the following display;

- ➊ TruBass LARGE
- ➋ TruBass MID
- ➌ TruBass SMALL

- ➍ Use the **MULTI CONTROL** knob or **MULTI** **△/▽** keys to adjust the TruBass Level.

- The adjustment range is from 0 (Trubass OFF) to 10.

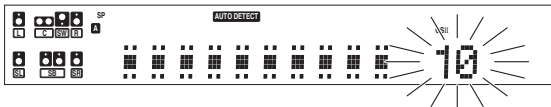

Display dimmer adjustment

The dimmer function lets you select the brightness of the receiver's display. You might find this useful if you darken your room to watch movies or listen to music.

Each time you press the **DIMMER** key, the display brightness changes among the three available settings. Select the brightness level you find most pleasing.

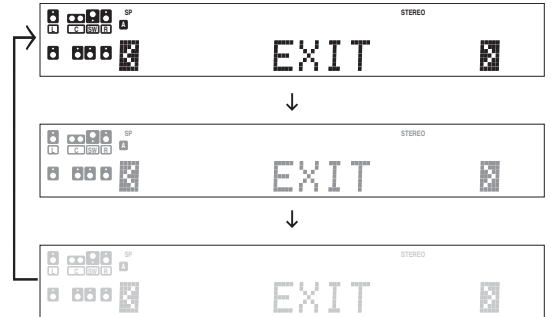

96kHz LPCM playback

The receiver is compatible with the 96kHz LPCM playback. To play a 96kHz DVD, set the listen mode to "STEREO".

- In **FULL AUTO** input mode the listen mode will automatically be STEREO.
- When in **DIGITAL MANUAL** input mode (listen mode is not STEREO), "96kHz LPCM" will appear in the display and no sound can be heard from the speakers. Press the **LISTEN MODE** or **STEREO** key (the listen mode changes to the STEREO mode) to output sound from the speakers.

Basic remote control operations for other components

The remote control supplied with this receiver is also capable of controlling components from a variety of manufacturers once you register the appropriate setup codes into the remote control unit.

Low battery warning

Replace all four batteries with new ones when you notice a shortening of the distance from which the remote control will operate. The remote control is designed to retain setup codes in memory while you change batteries.

- To initialize the remote control, press and hold the LEARN key for 3 seconds until the IR indicator blinks twice, then release the LEARN key. And then press the numeric key to enter "9-8-1". The IR indicator will blink twice as confirmation.

Registering setup codes for other components

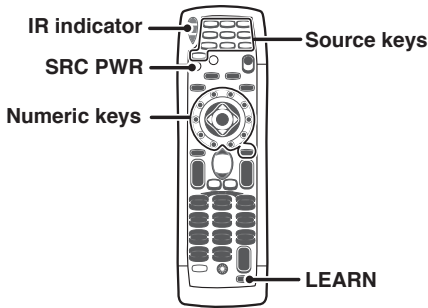

1 Find the setup code of the component to be registered.

- Refer to the setup code lists to find the setup code for the component to be registered. → [43](#)
- Example: To register a DVD made by KENWOOD, you would enter "0534".

Input	Component	Maker	Code	Key
(DVD)	DVD player	KENWOOD	0534	DVD/6CH

Source key	Other components
DVD/6CH	DVD
CD/DVD	CD and MD (Kenwood)
MD/TAPE	Cassette deck (Kenwood)
VIDEO1, AV AUX	VCR and PVR
VIDEO2	Cable and DTV decoder
VIDEO3	DSS
PHONO	Additional key for re-assigning
TV	TV/VCR combo, TV/DVD combo, TV

2 Press the Source keys (DVD/6CH, CD/DVD, VIDEO1, VIDEO2, VIDEO3, MD/TAPE, TV, AV AUX, PHONO).

- PHONO key has to re-assigned to another key before a setup code can be registered. → [43](#)
- While in Tuner mode, setup code function will not be available.

3 Press and hold the LEARN key for 3 seconds until the IR indicator blinks twice, then release the LEARN key.

4 Press the Numeric keys to enter the four-digit code for the component to be registered.

- If performed correctly, the IR indicator will blink twice as confirmation.
- Point the remote control at the component and press SRC Power key once. It should turn on/off but if it does not, repeat step 2 to 4.
- If the component still does not work, try searching for the code.

5 Repeat steps 2 to 4 to register additional components until all components have been registered.

Note

Although each setup code is designed to work with a number of different models, certain codes may not work with some models. (Also, certain codes may only operate some of the functions available on a given model.)

Searching for your codes

If your component does not respond after trying all the codes listed for your component, or if your component is not listed at all, try searching for your code.

For example, to search for code for your TV:

1 Press the TV key once. Next, press and hold the LEARN key for 3 seconds until the IR indicator blinks twice, then release the LEARN key.

2 Press the numeric key to enter "9 - 9 - 1".

- The IR indicator will blink twice as confirmation.

3 Point the remote control at the TV and slowly alternate between pressing the TV PWR and TV keys.

- Stop when the TV turns on or off.
- In the search mode, the remote control will send IR codes from its library to the selected device, starting with the most popular code first.

4 Press the LEARN key once to lock in the code.

5 To search for the codes of your other components, repeat steps 1 through 4, but substitute the appropriate key (i.e., DVD/6CH, CD/DVD, VIDEO1, VIDEO2, VIDEO3, MD/TAPE, TV, AV AUX, PHONO, SRC PWR).

- PHONO key has to be re-assigned to another key before a setup code can be programmed.

Checking the codes

If you have setup the remote control using the procedures described in "Searching for your codes", you may need to find out which four-digit code is operating your equipment:

For example, to find out which code is operating your TV:

1 Press the **TV** key once. Next, press and hold the **LEARN** key for 3 seconds until the IR indicator blinks twice, then release the **LEARN** key.

2 Press the numeric key to enter "9 - 9 - 0".

- The IR indicator will illuminate twice as confirmation.

3 To view the code for the first digit, press "1" once. Counts the number of times the IR indicator blinks (e.g. blinks=3) and write down that number.

- If a code digit is "0", the IR indicator will not illuminate.

4 Repeat step 3 three more times for the remaining digits. Use "2" for the second digit, "3" for the third digit, and "4" for the fourth digit.

5 To check the codes of your other components, repeat steps 1 through 4, but substitute the appropriate key (i.e. DVD/6CH, CD/DVD, VIDEO1, VIDEO2, VIDEO3, MD/TAPE, TV, AV AUX, PHONO) for the component you are checking.

- As suggested earlier on, write down each of the four-digit code.
- **PHONO** key has to be re-assigned to another key before a setup code can be programmed.

Re-assigning device keys

The remote control can be setup to control second TV or VCR, or any combination of nine home entertainment components.

For example, to control the operation of two different VCR using the remote control, the user need to re-assign the unused **VIDEO2** key to operate the second VCR(VIDEO1) as follows:

1 Press and hold the **LEARN** key for 3 seconds until the IR indicator blinks twice, then release the **LEARN** key.

2 Press the numeric key to enter "9 - 9 - 2".

- The IR indicator will blink twice as confirmation.

3 Press **VIDEO1** key once, then press the **VIDEO2** key once.

- The user now can operate VIDEO2 as a second VCR along with VIDEO1.
- Refer to the table in the previous page for the combination of source keys and the other components assignment. → 40

4 To re-assign other device keys, repeat steps 1 through 3 by substituting the key sequence from the below chart for the most popular components:

To re-assign key

Sequence	Perform
TV as 2nd VIDEO1 key	Learn - 9 - 9 - 2 VIDEO1 - TV
TV as 2nd VIDEO2 key	Learn - 9 - 9 - 2 VIDEO2 - TV
TV as 2nd CD/DVD key	Learn - 9 - 9 - 2 CD/DVD - TV
TV as 2nd TV key	Learn - 9 - 9 - 2 TV - TV
VIDEO1 as 2nd TV key	Learn - 9 - 9 - 2 TV - VIDEO1
VIDEO1 as 2nd VIDEO2 key	Learn - 9 - 9 - 2 VIDEO2 - VIDEO1
VIDEO1 as 2nd CD/DVD key	Learn - 9 - 9 - 2 CD/DVD - VIDEO1
VIDEO1 as 2nd VIDEO1 key	Learn - 9 - 9 - 2 VIDEO1 - VIDEO1

5 To clear the re-assignment and reset the remote control to its original operation mode:

1 Press and hold the **LEARN** key for 3 seconds until the IR indicator blinks twice, then release the **LEARN** key.

2 Press the numeric key to enter "9 - 9 - 2".

3 Press **VIDEO2** key twice.

- When a re-assignment is done, the IR indicator will blink twice to confirm your choice. At that time, you will need to program the remote control in order to control the new component.
- If an invalid key sequence is entered, the IR indicator will blink once and return to normal operation.
- When in Tuner mode, re-assignment is not available.

Operating other components

This operation lets you operate the registered components. KENWOOD audio components with system control turn on and off automatically with the receiver via the system control connections.

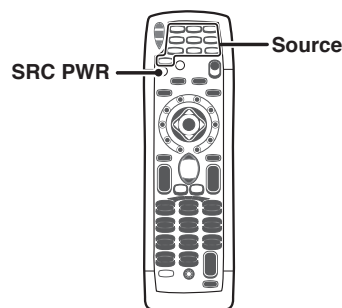

1 Use the **Source** keys to select the component you desire.

- Pressing the Source keys also changes the input selector on the receiver.
- When you operate your registered DVD player, CD player, Cable, DSS, DTV Decoder or VCR, go to step 2.
- When you operate the CD player, Cassette deck, MD player, or Tuner with system control connection, go to step 3.

2 Press the **SRC PWR** key.

3 Press the operation keys you desire. → 47

The remote control mode remains at the selected input. If you wish to operate another component, repeat step 2 or 3.

Storing the remote control code of the other components

This remote control unit can store the remote control code of the other components and you can operate the other components from this remote control unit. The remote control code is stored on the key or memory of this remote control unit.

Storing on the keys

You can store the remote control code of the other components to these keys as shown below:

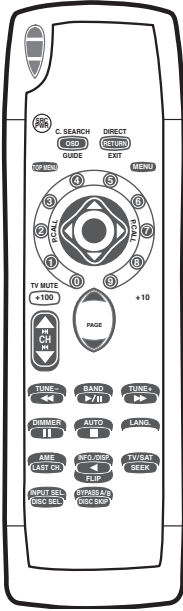

1 Point the infrared ray system part of the other component's remote control unit to the IR indicator of this remote control unit.

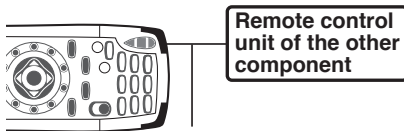

Infrared ray system part

- This remote control is ready to receive the remote control code of the other component.

2 Press and hold the LEARN key for 3 seconds until the IR indicator blinks twice, then release the LEARN key.

3 Press the Numeric keys to enter "9 - 7 - 5".

- The IR indicator will blink twice as confirmation.

4 Press any of the Source keys (DVD/6CH, CD/DVD, VIDEO1, VIDEO2, VIDEO3, MD/TAPE, TV, AVAUX, PHONO) to select the input of the desired remote control unit.

- When in Tuner mode, learning code function will not be available.

5 Press the desired key on the remote control unit.

6 From the remote control of the other component, press the key which you want to store.

- If the process is successful, the IR indicator will blink twice. Repeat from step **2** onwards up to the limit of the memory.
- If the code cannot be stored, the IR indicator will display one long blink. Try again by repeating from step **2** onwards.

7 The remote control code of the other component is stored on the key of this remote control unit.

8 Repeat steps **4** to **7** to store additional components until all the desired components are stored.

9 Press the LEARN key again to exit the learning mode.

10 To clear the stored remote control code of the other components :

- 1 Press and hold the LEARN key for 3 seconds until the IR indicator blinks twice, then release the LEARN key.
- 2 Press the Numeric keys to enter "9 - 7 - 6".
 - The IR indicator will blink twice as confirmation.
- 3 Press the Source key, then press the stored key twice.
 - The IR indicator will blink twice as confirmation.

Note

- Be sure to point the remote control at the remote sensor on the receiver when you want to operate KENWOOD components connected by system control cords. Otherwise, point the remote control at the component you want to operate.

Setup code chart

Cassette deck setup codes

Maker	Setup codes
Kenwood	0070, 0071, 0092, 0183, 0205, 0251, 0386
Sharp	0205
Yamaha	0205

CD player setup codes

Maker	Setup codes
Kenwood	0028, 0037, 0190, 0338, 0339, 0340, 0523, 0626, 0677, 0858, 0859, 1490
Marantz	0626
Optimus	0037
Philips	0626
Sharp	0037
Yamaha	0036

MD recorder setup codes

Maker	Setup codes
Kenwood	0681, 0826

Setup codes for Kenwood components with System Control connection

Maker	Setup codes
CD	1353
MD	1359
Cassette deck	0234

TV setup codes

Maker	Setup codes
A-Mark	0003
AOC	0003, 0019, 0030, 0052, 0137, 0185
Abex	0032
Admiral	0093, 0463
Adventura	0046
Aiko	0092
Aiwa	0701
Akai	0030, 0098, 0702
Alaron	0179, 0183, 0216
America Action	0180
Ampro	0751
Anam	0004, 0009, 0068, 0180
Anam National	0055, 0161
Apex Digital	0748, 0765, 0767
Archer	0003
Audiovox	0003, 0092, 0180, 0451, 0623
Baysonic	0180
Belcor	0019
Bell & Howell	0016, 0154
Bradford	0180
Brockwood	0019
Broksonic	0003, 0236, 0463
CCE	0217, 0329
CXC	0180
Candle	0030, 0046, 0056, 0186
Carnivale	0030
Carver	0054
Celebrity	0000
Celera	0765
Changhong	0765
Cineral	0092, 0451
Citizen	0030, 0039, 0046, 0056, 0060, 0092, 0186, 0280
Clairtone	0185
Clarion	0180
Concerto	0056
Contec	0157, 0158, 0180, 0185
Craig	0161, 0180
Crosley	0054
Crown	0039, 0180
Curtis Mathes	0016, 0030, 0039, 0047, 0054, 0056, 0060, 0093, 0145, 0154, 0166, 0451, 0466, 0702, 0747, 1147, 1347
Daewoo	0019, 0039, 0091, 0092, 0451, 0623
Daytron	0019
Denon	0145
Dumont	0017, 0019
Dwin	0720, 0774
Dynatech	0049
Electroband	0000, 0185
Electrohome	0381, 0389, 0409
Emerson	0019, 0038, 0039, 0154, 0158, 0178, 0179, 0180, 0181, 0182, 0183, 0185, 0236, 0270, 0280, 0282, 0463, 0623
Envision	0030
Fisher	0154, 0159
Fujitsu	0179, 0683
Funai	0171, 0179, 0180
Futuretech	0180

Maker	Setup codes
GE	0021, 0027, 0029, 0047, 0051, 0055, 0135, 0174, 0178, 0251, 0279, 0282, 0451, 0747, 1147, 1347
Gibralter	0017, 0019, 0030
GoldStar	0001, 0002, 0019, 0030, 0032, 0106, 0178, 0409
Gradiente	0053, 0056, 0392
Grunpy	0179, 0180
Haier	0768
Hallmark	0178
Harley Davidson	0179
Harman/Kardon	0054, 0078
Harvard	0068, 0180
Havermy	0093
Hitachi	0016, 0032, 0038, 0056, 0097, 0145, 0151, 0279, 0409, 0413, 1145
IRT	0628
Infinity	0054
Inteq	0017
JBL	0054
JCB	0000
JVC	0036, 0053, 0069, 0160, 0169, 0182, 0463
Janeil	0046
KEC	0180
KMC	0106
KTV	0030, 0039, 0180, 0183, 0185, 0217, 0280
Kamp	0216
Kawasho	0158, 0216
Kaypani	0052
Kenwood	0019, 0030
Kloss	0024, 0046, 0078
Konka	0628, 0632, 0638, 0703, 0707
LG	0056
LXI	0047, 0054, 0148, 0154, 0156, 0178, 0747
Logik	0016
Luxman	0056
MEI	0185
MGA	0019, 0030, 0150, 0155, 0178
MTC	0019, 0030, 0049, 0056, 0060, 0091, 0185, 0216
Magnavox	0020, 0024, 0028, 0030, 0036, 0054, 0096, 0179, 0186, 0187, 0230, 0386, 1254, 1454
Majestic	0015, 0016
Marantz	0030, 0054
Matsushita	0250
Megatron	0003, 0145, 0178
Memorex	0016, 0106, 0150, 0154, 0178, 0179, 0250, 0463
Mercury	0001
Midland	0017, 0032, 0039, 0047, 0051, 0135, 0747
Minutz	0021
Mitsubishi	0014, 0019, 0093, 0098, 0150, 0155, 0178, 0331, 0358
Motorola	0055, 0093
Multitech	0049, 0180, 0217
NAD	0156, 0166, 0178
NEC	0019, 0030, 0036, 0056, 0497

Setup code chart

TV setup codes (continue)

Maker	Setup codes
NTC	0092
Nikko	0030, 0092, 0178
Noblex	0430
Noshi	0018
Onwa	0180
Optimus	0154, 0166, 0250
Optonica	0093, 0165
Orion	0179, 0236, 0463
Panasonic	0051, 0055, 0226, 0250
Penney	0002, 0003, 0018, 0019, 0021, 0027, 0030, 0032, 0039, 0047, 0051, 0060, 0110, 0135, 0156, 0178, 0747, 1347,
Philco	0019, 0020, 0028, 0030, 0054, 0096, 0145, 0463
Philips	0054, 1454
Pilot	0019, 0030, 0039
Pioneer	0038, 0166, 0679
Portland	0019, 0039, 0092
Princeton	0717
Prism	0051
Proscan	0047, 0747
Proton	0003, 0031, 0052, 0178, 0466
Pulsar	0017, 0019
Quasar	0051, 0055, 0165, 0219, 0250
RCA	0018, 0019, 0029, 0038, 0047, 0090, 0135, 0174, 0278, 0679, 0747, 1047, 1147, 1247, 1347, 1447, 1547
RadioShack	0019, 0030, 0032, 0039, 0047, 0056, 0154, 0165, 0178, 0180, 0409, 0747
Realistic	0019, 0030, 0032, 0039, 0056, 0154, 0165, 0178, 0180
Rhapsody	0183, 0185, 0216
Runco	0017, 0030, 0251, 0497, 0603
SSS	0019, 0180
Sampo	0030, 0032, 0039, 0052, 0110
Samsung	0019, 0030, 0032, 0056, 0060, 0178, 0329, 0427, 0482, 0702, 0766
Samsux	0039
Sansei	0451
Sansui	0463
Sanyo	0146, 0154, 0159, 0484
Scimitsu	0019
Scotch	0178
Scott	0019, 0178, 0179, 0180, 0236
Sears	0015, 0047, 0054, 0056, 0146, 0148, 0154, 0156, 0159, 0171, 0178, 0179, 0281, 0747
Semivox	0180
Semp	0156
Sharp	0039, 0093, 0153, 0157, 0165, 0281, 0386, 0491, 0688, 0689
Shogun	0019
Signature	0016
Simpson	0186, 0187

Maker	Setup codes
Sony	0000, 0011, 0080, 0111, 1400
Soundesign	0178, 0179, 0180, 0186
Spectricon	0003, 0137
Squareview	0171
Starlite	0180
Supre-Macy	0046
Supreme	0000
Sylvania	0020, 0028, 0030, 0054, 0065, 0096, 0171, 0381
Symphonic	0171, 0180
TMK	0056, 0178
TNCi	0017
TVS	0463
Tandy	0093
Tatung	0003, 0049, 0055
Technics	0051, 0250
Technol Ace	0179
Techwood	0003, 0051, 0056
Teknika	0016, 0019, 0039, 0054, 0056, 0060, 0092, 0150, 0179, 0180, 0186, 0312
Telefunken	0056, 0702
Tera	0031
Toshiba	0036, 0060, 0154, 0156, 1256
Tosonic	0185
Totevision	0039
Trical	0157
Universal	0027
Vector Research	0030
Victor	0053
Video Concepts	0098
Vidikron	0054, 0242
Vidtech	0019, 0036, 0178
Viking	0046, 0312
Wards	0016, 0019, 0020, 0021, 0027, 0028, 0029, 0030, 0054, 0056, 0080, 0096, 0111, 0165, 0174, 0178, 0179
Waycon	0156
White Westinghouse	0463, 0623
Yamaha	0019, 0030, 0769
Zenith	0016, 0017, 0092, 0178, 0463
Zonda	0003

VCR setup codes

Maker	Setup codes
Admiral	0048, 0209
Adventura	0000
Aiko	0278
Aiwa	0000, 0037, 0307
Akai	0041, 0049, 0053, 0061, 0106
American Action	0278
American High	0035
Asha	0240
Audiovox	0037, 0278
Beaumarck	0240
Bell & Howell	0104
Broksonic	0002, 0121, 0184, 0209, 0211, 0295, 0361, 0479, 1479
CCE	0072, 0278
Calix	0037
Canon	0035, 0102
Capehart	0020
Carver	0081
Cineral	0278
Citizen	0037, 0278, 1278
Colt	0072
Craig	0037, 0047, 0072, 0240, 0271
Curtis Mathes	0035, 0041, 0060, 0162, 0760, 1035
Cybernex	0051, 0240
Daewoo	0020, 0045, 0278, 0561, 1278
Daytron	0020
Denon	0042
Dynatech	0000
Electrohome	0037
Electroponic	0037
Emerex	0032
Emerson	0000, 0002, 0036, 0037, 0043, 0061, 0068, 0088, 0121, 0184, 0208, 0209, 0211, 0212, 0278, 0294, 0295, 0361, 0479, 0510, 0561, 1278, 1479
Fisher	0047, 0054, 0066, 0104
Fuji	0033, 0035
Funai	0000
GE	0035, 0060, 0065, 0202, 0240, 0760, 0761, 0807, 1035, 1060
Garrard	0000
Go Video	0232, 0279, 0432, 0526, 0643
GoldStar	0037, 0038, 1237
Gradiente	0000, 0008, 0408
Grundig	0195
HI-Q	0047
Harley Davidson	0000
Harman/Kardon	0038, 0075, 0081
Harwood	0068, 0072
Headquarter	0046
Hitachi	0000, 0041, 0042, 0065, 0082, 0105, 0166
Hughes Network Systems	0042
JVC	0008, 0041, 0067, 0206
Jensen	0041
KEC	0037, 0278
KLH	0072
Kenwood	0038, 0041, 0067
Kodak	0035, 0037
LXI	0037

Setup code chart

VCR setup codes (continue)

Maker	Setup codes
Lloyd's	0000, 0208
Logik	0072
MEI	0035
MGA	0043, 0061, 0240
MGN Technology	0240
MTC	0000, 0240
Magnasonic	1278
Magnavox	0000, 0035, 0039, 0081, 0110, 0149, 0563, 1781
Magnin	0240
Marantz	0035, 0081
Marta	0037
Matsushita	0035, 0162, 0454
Memorex	0000, 0035, 0037, 0039, 0046, 0047, 0048, 0104, 0162, 0209, 0240, 0307, 0454, 0479, 1037, 1162, 1237, 1262
Minolta	0042, 0105
Mitsubishi	0043, 0061, 0067, 0075, 0173, 0443, 0807
Motorola	0035, 0048
Multitech	0000, 0072
NAD	0058
NEC	0038, 0040, 0041, 0067, 0082, 0104
Nikko	0037
Nikon	0034, 0253
Noblex	0240
Olympus	0035, 0226
Optimus	0037, 0048, 0058, 0104, 0162, 0432, 0454, 1048, 1062, 1162, 1262
Optonica	0062
Orion	0002, 0184, 0209, 0295, 0479, 1479
Panasonic	0035, 0077, 0102, 0162, 0225, 0226, 0378, 0454, 0616, 1035, 1062, 1162, 1262
Penney	0035, 0037, 0038, 0040, 0042, 0054, 0240, 1035, 1237
Pentax	0042, 0065, 0105
Philco	0035, 0209, 0479
Philips	0035, 0062, 0081, 0110, 0618, 1081, 1181
Pilot	0037
Pioneer	0058, 0067
Polk Audio	0081
Portland	0020
Profitronic	0240
Proscan	0060, 0202, 0760, 0761, 1060
Protec	0072
Pulsar	0039, 0051
Quarter	0046
Quartz	0046
Quasar	0035, 0077, 0162, 0454, 1035, 1162
RCA	0042, 0058, 0060, 0065, 0077, 0105, 0106, 0149, 0202, 0240, 0760, 0761, 0807, 1035, 1060
RadioShack	0000, 1037
Radix	0037
Randex	0037

Maker	Setup codes
Realistic	0000, 0035, 0037, 0046, 0047, 0048, 0062, 0066, 0104
ReplayTV	0614, 0616
Ricoh	0034, 0253
Runco	0039
STS	0042
Salora	0075
Samsung	0045, 0051, 0053, 0240
Samtron	0643
Sanky	0039, 0048
Sansui	0000, 0041, 0067, 0082, 0209, 0271, 0479, 1479
Sanyo	0046, 0047, 0104, 0240
Scott	0043, 0045, 0121, 0184, 0210, 0211, 0212
Sears	0000, 0035, 0037, 0042, 0046, 0047, 0054, 0066, 0104, 0105, 1237
Semp	0045
Sharp	0048, 0062, 0738, 0807, 0848
Shintom	0072
Shogun	0051, 0240
Singer	0072
Sonic Blue	0614, 0616
Sony	0000, 0032, 0033, 0034, 0035, 0253, 0636, 1032, 1232
Sunpak	0253
Sylvania	0000, 0035, 0043, 0081, 0110, 1781
Symphonic	0000
TMK	0036, 0208, 0240
Tatung	0041
Teac	0000, 0041
Technics	0035, 0162
Teknika	0000, 0035, 0037
Thomas	0000
Tivo	0618, 0636
Toshiba	0043, 0045, 0066, 0120, 0212, 0366, 0845
Totevision	0037, 0240
Unitech	0240
Vector	0045
Vector Research	0038, 0040
Video Concepts	0040, 0045, 0061
Videomagic	0037
Videosonic	0240
Villian	0000
Wards	0000, 0035, 0042, 0047, 0048, 0060, 0062, 0072, 0081, 0149, 0212, 0240, 0760
White Westinghouse	0072, 0209, 1278
XR-1000	0000, 0035, 0072
Yamaha	0038
Zenith	0000, 0033, 0034, 0039, 0209, 0479, 0637, 1479

DSS Setup codes

Maker	Setup codes
AlphaStar	0772
Chaparral	0216
Crossdigital	1109
DishPro	0775, 1005
Echostar	0775, 1005
Expressvu	0775
GE	0566
GOI	0775
General Instrument	0869
HTS	0775
Hitachi	0819
Hughes Network Systems	0749, 1142, 1749
JVC	0775
Magnavox	0722, 0724
Memorex	0724
Mitsubishi	0749
Motorola	0869
Next Level	0869
Panasonic	0247, 0701
paysat	0724
Philips	0722, 0724, 0749, 1076, 1142, 1749
Proscan	0392
RCA	0143, 0392, 0566, 0855
RadioShack	0869
SKY	0856
Samsung	1109
Sony	0639
Star Choice	0869
Toshiba	0749, 0790, 1749
Uniden	0722, 0724
Zenith	0856, 1856

Setup code chart

Cable setup codes

Maker	Setup codes
ABC	0001, 0003, 0007, 0008, 0011, 0013, 0014, 0017
Allegro	0153, 0315
Americast	0899
Antronix	0022
Archer	0022, 0153, 0797
Belcor	0056
Bell & Howell	0014
Bell South	0899
Cable Star	0056
Cabletenna	0022
Cableview	0022
Century	0153
Citizen	0153, 0315
Colour Voice	0025
Comtronics	0040
Contec	0019
Digi	0637
Director	0476
Eastern	0002
Emerson	0797
Everquest	0015, 0040
Focus	0400
GC Electronics	0056
Garrard	0153
Gemini	0015, 0797
General Instrument	0003, 0011, 0276, 0476, 0810
GoldStar	0040, 0144
Goodmind	0797
Hamlin	0009, 0020, 0034, 0259, 0273
Hitachi	0011
Hytex	0007
Jasco	0015, 0153, 0315
Jerrold	0003, 0011, 0012, 0014, 0015, 0276, 0476, 0810
Linsay	0440
Memorex	0000
Motorola	0276, 0476, 0810, 1106
Movie Time	0063
NSC	0063
Oak	0007, 0019
Optimus	0021
Pace	0237
Panasonic	0000, 0021, 0107
Panther	0637
Paragon	0000
Philips	0025, 0153, 0305, 0317
Pioneer	0144, 0533, 0877, 1877
Popular Mechanics	0400
Pulsar	0000
Quasar	0000
RCA	0021
RadioShack	0015, 0315, 0797, 0883
Recoton	0400
Regal	0020, 0259, 0273, 0279
Regency	0002
Rembrandt	0011
Runco	0000
SL Marx	0040
Samsung	0040, 0144
Scientific Atlanta	0008, 0017, 0477, 0877, 1877
Signal	0015, 0040
Sinature	0011
Sony	1006
Sprucer	0021
Starcom	0003, 0015

Maker	Setup codes
Stargate	0015, 0040, 0797
Srarquest	0015
Supercable	0276
Sylvania	0001
TV86	0063
Tandy	0258
Televiow	0040
Texscan	0001
Tocom	0012, 0013
Torx	0003
Toshiba	0000
Tusa	0015
Unika	0022, 0153
United Artists	0007
Universal	0022, 0056, 0153, 0191
ViewMaster	0883
Viewstar	0063, 0258
Zenith	0000, 0525, 0899
Zentek	0400

DTV Decoders setup codes

Maker	Setup codes
Panasonic	1120
Pioneer	1010
Princeton	0113, 0295
Samsung	1190
Sensory Science	1126
Sharp	1010

DVD Decoders setup codes

Maker	Setup codes
Aiwa	0641
Amoisonic	0835
Apex Digital	0672, 0717, 0755, 0794, 0795, 0796, 0797, 0830, 0856
Audiologic	0736
B & K	0655, 0662
Blaupunkt	0717
Blue Parade	0571
Broksonic	0695, 0868
Cyber Home	0816
DVD2000	0521
Daewoo	0784
Denon	0490, 0634
Emerson	0591
Enterprise	0591
Fisher	0670
GE	0522, 0717, 0815
GPX	0699, 0769
Go Video	0715, 0783
Gradiente	0651
Greenhill	0717
Harman/Kardon	0582, 0702
Hitachi	0573, 0664
Hiteker	0672
IRT	0783
Integra	0627
JBL	0702
JVC	0558, 0623, 0867
KLH	0717
Kenwood	0490, 0534, 0682, 0737
Konka	0711, 0719, 0721
Koss	0651
Lasonic	0798
Magnavox	0503, 0675
Malata	0782

Maker	Setup codes
Marantz	0539
Microsoft	0522
Mintek	0717, 0839
Mitsubishi	0521
Nesa	0717
Next Base	0826
Norcent	0872
Onkyo	0503, 0627
Oritron	0651
Panasonic	0490, 0632, 1362, 1462, 1490
Philips	0503, 0539, 0646, 0854
Pioneer	0525, 0571, 0632
Polk Audio	0539
Princeton	0674
Proscan	0522
Qwestar	0651
RCA	0522, 0571, 0717, 0822, 1022
Raite	0665
Rotel	0623
Rowa	0823
Sony	0533, 0864, 1033
Sylvania	0675, 0821
Technics	0490
Techwood	0692
Theta Digital	0571
Sanyo	0670, 0695
Sharp	0630
Sherwood	0633
Shinsonic	0533, 0839
Sampo	0698
Samsung	0573, 0820
Sansui	0695
Theta Digital	0571
Toshiba	0503, 0695, 1045
Tredex	0799, 0800, 0803
Urban Concepts	0503
XBox	0522
Yamaha	0490, 0539, 0545, 0817
Yamakawa	0665, 0710
Zenith	0503, 0591

CASSETTE deck, CD player & MD recorder operations

You can perform these basic operations using the keys described below when connected to KENWOOD cassette deck, CD player or MD recorder equipped with system control operations. - 22

Cassette deck operations keys

CD player and MD recorder operations keys

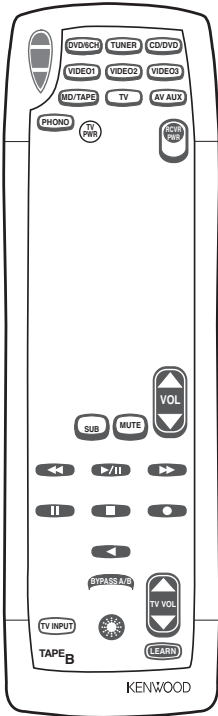

MAIN screen

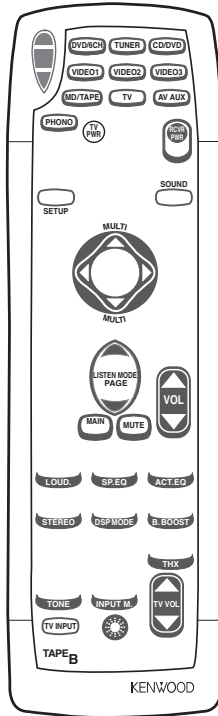

SUB screen

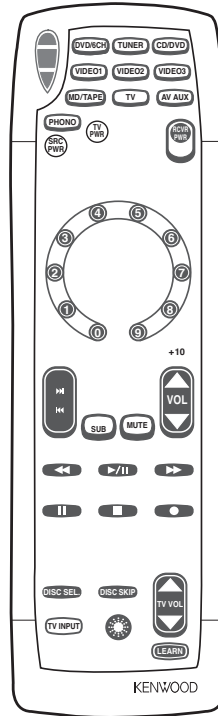

MAIN screen

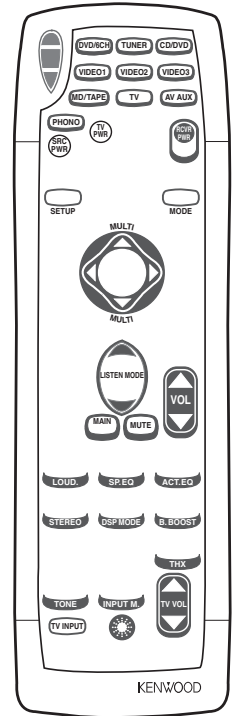

SUB screen

Other components' operations

Refer to the following for the type of remote control operations available for each component.

- 1 Select the input source.
- 2 Press the keys corresponding to the operations you desire. Refer to the following sections for details.

- When pressing keys in succession, press each key firmly and be sure to wait at least 1 second before pressing the next key.
- Numeric keys function the same as the numeric keys on the original remote.

These keys can be used to perform the basic operations of KENWOOD and other manufacturers' components which the setup code for each component had been entered beforehand.

TV operation keys

VCR and PVR operation keys

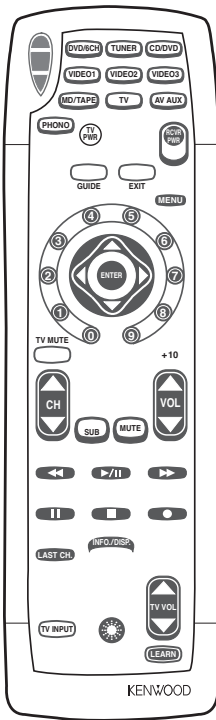

MAIN screen

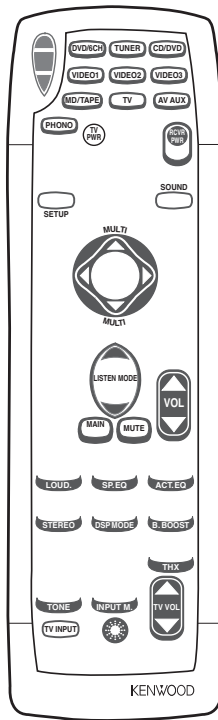

SUB screen

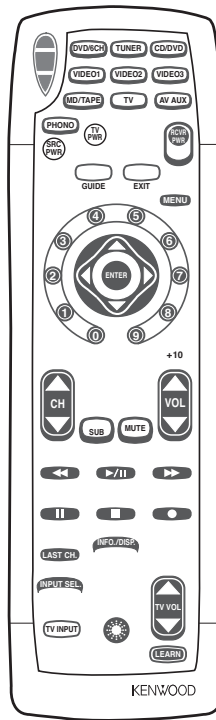

MAIN screen

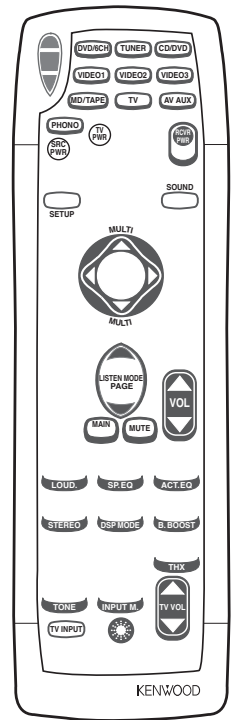

SUB screen

DSS operation keys

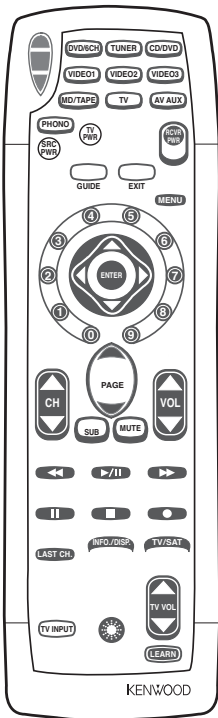

MAIN screen

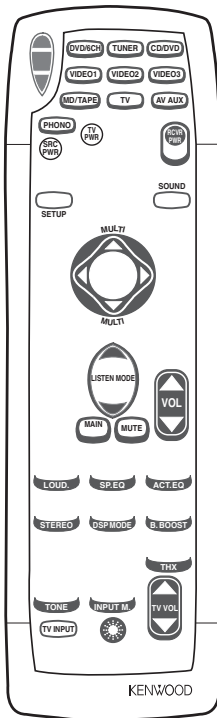

SUB screen

Cable and DTV decoder operation keys

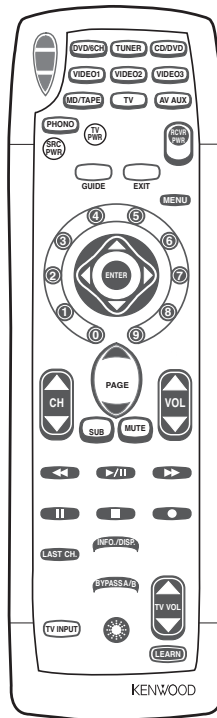

MAIN screen

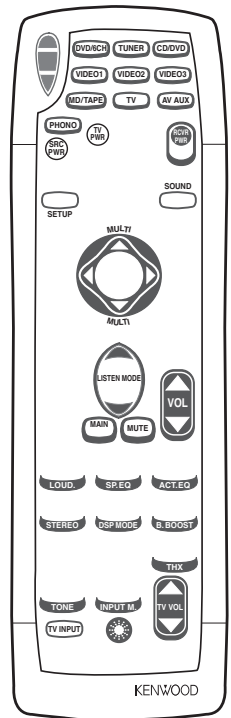

SUB screen

DVD player operation keys

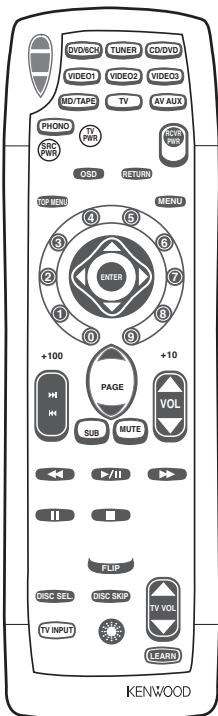

MAIN screen

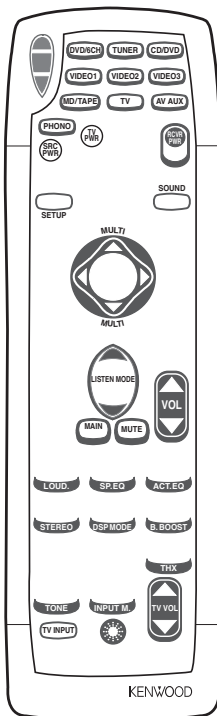

SUB screen

PHONO operations keys

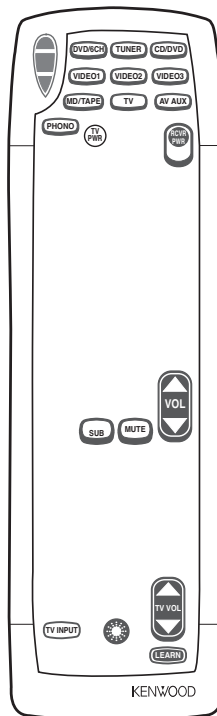

MAIN screen

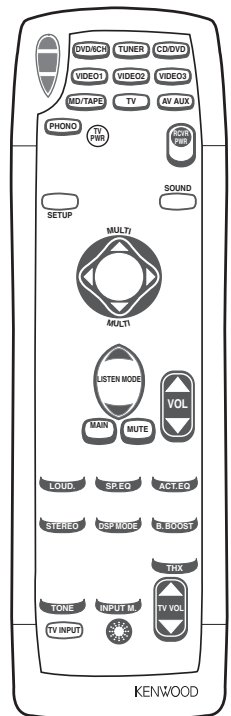

SUB screen

In case of difficulty

Resetting the Microcomputer

The microcomputer may malfunction (unit cannot be operated, or shows an erroneous display) if the power cord is unplugged while the power is ON, or due to some other external factor. If this happens, execute the following procedure to reset the microcomputer and return the unit to its normal operating condition.

- Please note that resetting the microcomputer will clear the contents of the memory and returns the unit to the state it was in when it left the factory.

For U.S.A. and Canada

Unplug the power cord from the wall outlet, then plug it back in while holding down the POWER ON/STANDBY  key.

For other countries

With the power cord plugged in, turn the POWER key OFF. Then, while holding down the ON/STANDBY  key, press POWER key.

Amplifier

Symptom	Cause	Remedy
No sound from the speakers.	<ul style="list-style-type: none"> • The speaker cords are disconnected. • VOLUME is set to the minimum position. • MUTE is ON. • The SPEAKERS switches are set to OFF. 	<ul style="list-style-type: none"> • Connect them properly referring to "Connecting the speakers" - 17 • Adjust the volume to a proper level. • Turn OFF the MUTE. - 27 • Set the SPEAKERS switches to ON. - 26
The standby indicator blinks and sound is not output.	<ul style="list-style-type: none"> • Speaker cords are short-circuited. 	<ul style="list-style-type: none"> • Turn the power off, eliminate the short-circuiting, then turn on the power again.
Sound is not output from one of the speakers.	<ul style="list-style-type: none"> • The speaker cord is disconnected. 	<ul style="list-style-type: none"> • Connect it properly referring to "Connecting the speakers". - 17
Sound is not output from the surround speakers and / or the center speaker, or their sound is very small.	<ul style="list-style-type: none"> • The surround speaker cords and/or the center speaker cord is disconnected. • A surround mode has not been engaged. • The surround and/or center volume controls are set to the minimum level. 	<ul style="list-style-type: none"> • Connect it properly referring to "Connecting the speakers". - 17 • Select a surround mode. • Adjust the speaker levels using the test tone. - 24
A humming noise is generated when the PHONO input selector is selected.	<ul style="list-style-type: none"> • The audio cord from the record player is not connected to the PHONO jacks. • The record player is not grounded. 	<ul style="list-style-type: none"> • Insert the audio cord plugs securely into the PHONO jacks. • Connect the grounding wire to the GND terminal on the rear panel.
When playing a Dolby Digital source signal using a DVD player, the sound is cut off soon after it starts.	<ul style="list-style-type: none"> • There are many possible causes for this problem, depending on the type of DVD player used. 	<ul style="list-style-type: none"> • Set the input mode to digital manual before starting playback of the Dolby Digital source. - 10
No sound is produced during playback from a DVD player.	<ul style="list-style-type: none"> • The input mode is set to digital manual. 	<ul style="list-style-type: none"> • Press the INPUT MODE key to select to full auto mode. - 10
A video source cannot be recorded normally.	<ul style="list-style-type: none"> • The software is copy-guarded. 	<ul style="list-style-type: none"> • Copy-guarded video software cannot be recorded.

Tuner

Symptom	Cause	Remedy
Radio stations cannot be received.	<ul style="list-style-type: none"> • No antenna is connected. • The broadcast band is not set properly. • The frequency of the desired station is not tuned. 	<ul style="list-style-type: none"> • Connect an antenna. - 21 • Set the broadcast band properly. • Tune the frequency of the desired station. - 30
Interference.	<ul style="list-style-type: none"> • Noise due to ignition noise from an automobile. • Noise due to interference from an electric appliance. • Noise due to a nearby TV set. 	<ul style="list-style-type: none"> • Install the outdoor antenna away from the road. • Turn off the power to the appliance. • Install the receiver farther away from the TV.
A station which was preset cannot be received by pressing the corresponding numeric key.	<ul style="list-style-type: none"> • The preset station belongs to a frequency that cannot be received. • The preset memory was cleared because the power cord had been unplugged for a long period of time. 	<ul style="list-style-type: none"> • Preset a station with a receivable frequency. • Preset the station again.

Remote control unit

Symptom	Cause	Remedy
<p>Certain inputs cannot be selected using the remote control.</p>	<ul style="list-style-type: none"> • No setup codes registered for the respective input(s). 	<ul style="list-style-type: none"> • Register a setup code at the respective input(s). → [43]
<p>Remote control operation is not possible.</p>	<ul style="list-style-type: none"> • The remote control is set to a different operation mode. • Batteries are exhausted. • The remote control unit is too far away from the main system, controlling angle is too large, or there is an obstacle between the receiver and the remote. • The audio cords and system control cords are not connected properly. • No tape or CD is placed in the source component. • An attempt is made to play a tape which is being recorded in the cassette deck. • The remote control has not been set to the operation mode for the component you wish to control. 	<ul style="list-style-type: none"> • Press the Input selector keys to select the appropriate operation mode. • Replace with new batteries. • Operate the remote control unit within the controllable range. • Connect properly referring to "Setting up the system". • Place the tape or CD in the source component which you want to play. • Wait until recording has completed. • Press any of the source keys or SRC PWR key to activate the operation mode for the component you want to control before operation. → [41]

Specifications

⚠ Caution : Read this page carefully to ensure safe operation.

AUDIO section

Rated power output during STEREO operation

100 watts per channel minimum RMS, both channels driven, at 8 Ω from 20 Hz to 20 kHz with no more than 0.09% total harmonic distortion. (FTC)

Effective power output during SURROUND operation (VR-7080)

FRONT (20 Hz ~ 20 kHz, 0.09 % T.H.D. at 8 Ω one channel driven) 100 W + 100 W
CENTER (20 Hz ~ 20 kHz, 0.09 % T.H.D. at 8 Ω one channel driven) 100 W
SURROUND (20 Hz ~ 20 kHz, 0.7 % T.H.D. at 8 Ω one channel driven) 100 W + 100 W
SURROUND BACK/SUBWOOFER (20 ~ 20 kHz, 0.09 % T.H.D. at 8 Ω one channel driven) 100 W

Effective power output during SURROUND operation (KRF-X9070D)

FRONT (20 Hz ~ 20 kHz, 0.09 % T.H.D. at 8 Ω one channel driven) 100 W + 100 W
FRONT (1 kHz, 10 % T.H.D. at 8 Ω one channel driven) 130 W + 130 W
CENTER (20 Hz ~ 20 kHz, 0.09 % T.H.D. at 8 Ω one channel driven) 100 W
CENTER (1 kHz, 10 % T.H.D. at 8 Ω one channel driven) 130 W
SURROUND (20 Hz ~ 20 kHz, 0.7 % T.H.D. at 8 Ω one channel driven) 100 W + 100 W
SURROUND (1 kHz, 10 % T.H.D. at 8 Ω one channel driven) 130 W + 130 W
SURROUND BACK/SUBWOOFER (20 ~ 20 kHz, 0.09 % T.H.D. at 8 Ω one channel driven) 100 W
SURROUND BACK/SUBWOOFER (1 kHz, 10 % T.H.D. at 8 Ω one channel driven) 130 W

Total harmonic distortion 0.009 % (1 kHz, 50 W, 8 Ω)

Frequency response

Line (CD/DVD, TAPE, VIDEO 1, VIDEO 2, VIDEO 3, DVD/6CH) 10 Hz ~ 100 kHz, 0 dB ~ -3.0 dB

PHONO 'RIAA' response 40 Hz ~ 20 kHz, +1.5 dB ~ -3.0 dB

Maximum input level

PHONO (MM) 45 mV, 1 % T.H.D. at 1 kHz

Signal to noise ratio (IHF'66)

PHONO (MM) 75 dB

Line (CD/DVD, TAPE, VIDEO 1, VIDEO 2, VIDEO 3, DVD/6CH) 95 dB

Loudness control

VOLUME at -30 dB level +6 dB (100 Hz)

Input sensitivity / impedance

PHONO (MM) 4 mV / 47 kΩ

Line (CD/DVD, TAPE, VIDEO 1, VIDEO 2, VIDEO 3, DVD/6CH) 320 mV / 47 kΩ

Output level / impedance

TAPE REC 320 mV / 1 kΩ

PRE OUT (FRONT, CENTER, SURROUND) 1 V / 500 Ω

PRE OUT (SURROUND BACK) 1 V / 500 Ω

PRE OUT (SUBWOOFER) 1 V / 500 Ω

Tone control

BASS ±10 dB (at 100 Hz)

TREBLE ±10 dB (at 10 kHz)

DIGITAL AUDIO section

Sampling frequency 32 kHz, 44.1 kHz, 48 kHz, 96 kHz

Input level / impedance / wave length

Optical (-15 dBm ~ -24 dBm), 660 nm ±30 nm

Coaxial 0.5 Vp-p / 75 Ω

Output level / impedance / wave length

Optical (-21 dBm ~ -15 dBm), 660 nm ±30 nm

VIDEO section

VIDEO inputs / outputs

VIDEO (composite) 1 Vp-p / 75 Ω

S-VIDEO inputs / outputs

S-VIDEO (luminance signal) 1 Vp-p / 75 Ω

S-VIDEO (chrominance signal) 0.286 Vp-p / 75 Ω

COMPONENT VIDEO inputs / outputs

COMPONENT VIDEO (luminance signal) 1 Vp-p / 75 Ω

COMPONENT VIDEO (CB/CR-signal) ±0.32 Vp-p / 75 Ω

FM tuner section

Tuning frequency range 87.5 MHz ~ 108.0 MHz

Usable sensitivity (MONO)

..... 1.3 μV (75 W) / 13.2 dBf (75 kHz dev, SINAD 30 dB)

50 dB quieting sensitivity

STEREO 28 μV (75 Ω) / 40.2 dBf

Total harmonic distortion

MONO (1 kHz, 75 kHz dev) 0.5% (65 dBf input)

STEREO (1 kHz, 67.5 + 6.75 kHz dev) 0.7% (65 dBf input)

Signal to noise ratio

MONO (1 kHz, 75 kHz dev) 75 dB (65 dBf input)

STEREO (1 kHz, 67.5 + 6.75 kHz dev) 68 dB (65 dBf input)

Stereo separation (1 kHz) 40 dB

Selectivity (±400 kHz) (VR-7080) 70 dB

(KRF-X9070D) 50 dB

Frequency response (30 Hz ~ 15 kHz) +0.5 dB, -3.0 dB

AM tuner section

Tuning frequency range

10 kHz step 530 kHz ~ 1,700 kHz (VR-7080)

10 kHz step 530 kHz ~ 1,610 kHz (KRF-X9070D)

9 kHz step 531 kHz ~ 1,602 kHz (KRF-X9070D)

Usable sensitivity (30% mod, S/N 20 dB) 16 μV / (600 μV/m)

Signal to noise ratio (30% mod, 400 Hz) 50 dB (60 dB μV EMF input)

GENERAL

Power consumption VR-7080 3 A

KRF-X9070D 300 W

Standby Power consumption less than 2W

AC outlet

SWITCHED VR-7080 (total 150 W, 1.25 A max.)

KRF-X9070D (total 90 W)

Dimensions W : 440 mm (17-5/16")

H : 159 mm (6-1/4")

D : 392 mm (15-7/16")

Weight (Net)

VR-7080 9.4 kg (20.7 lb)

KRF-X9070D 10.2 kg (22.5 lb)

Notes

1. KENWOOD follows a policy of continuous advancements in development. For this reason specifications may be changed without notice.
2. The full performance may not be exhibited in an extremely cold location (under a water-freezing temperature).

For your records

Record the serial number, found on the back of the unit, in the spaces designated on the warranty card, and in the space provided below. Refer to the model and serial numbers whenever you call upon your dealer for information or service on this product.

Model _____ Serial Number _____

KENWOOD